

Faber Special Gas  
2015-2016



**faber**

Since 1844

# On fire since 1844

---

## NL Warmte creëer je samen!

Wist u dat van het huidige aanbod van sfeerhaarden in de markt een zeer groot deel is gebaseerd op de innovatie van Faber? Faber is de uitvinder van het gesloten ook wel multivalent verbrandingssysteem genoemd. Faber neemt daarmee in Europa een zeer prominente positie in. Andere innovaties door de jaren heen zijn o.a. de Step Burner®, het unieke Opti-myst effect en de vuurbeleving Opti-Virtual®. Nieuw is de I.T.C. app, met deze App kunt u genieten van een mooi vlammenbeeld en toch tot 70% kunt besparen op uw energieverbruik! In deze brochure presenteren wij ons assortiment gashaarden. Naast gashaarden vindt u bij Faber ook een groot assortiment elektrische haarden en vrijstaande houtkachels.

Laat u inspireren!

## E Heat is created together!

Did you know that a large part of the current supply of atmospheric fires is based on a Faber innovation? Faber is the inventor of the enclosed or Multi-Vent burning system. That is why Faber holds a very prominent position in Europe. Other innovations throughout the years have included the Step Burner®, the unique Opti-myst effect and the fire illusion experience Opti-Virtual®. New is our state-of-the-art I.T.C. app, with this App you can control your fire using your mobile phone or tablet and enjoy the illusion of flames and yet save up to 70% in energy use! In this brochure we will introduce our new range of gas fires. Besides gas fires, you will also find an extensive range of electric fires and free-standing wood burning stoves at Faber's.

Be inspired!

## D Gemeinsam Wärme schaffen!

Wussten Sie, dass ein sehr großer Teil des heutigen Angebots von Gaskaminen am Markt Innovationen von Faber zugrunde liegen? Faber ist der Erfinder des raumluftunabhängigen Verbrennungssystems, auch Multi-Vent-Verbrennungssystem genannt. Faber nimmt damit in Europa eine herausragende Position ein. Eine weitere Innovation im Laufe der Jahre ist u.a. der Step Burner®. Neu ist die I.T.C. App. Mit dieser App können Sie Ihrem Kamin mit Ihrem Smartphone oder Tablet bedienen, ein schönes Flammenbild genießen und trotzdem bis zu 70% Energie sparen! In dieser Broschüre präsentieren wir unser Gaskamin-Sortiment. Neben Gaskaminen finden Sie bei Faber auch ein großes Sortiment an Elektrokaminen und frei freistehenden Holzöfen.

Lassen Sie sich inspirieren!

## F Créons la chaleur ensemble!

Saviez-vous que la plupart de l'offre des foyers à gaz actuel est basé sur une innovation de Faber? Faber a inventé le système de combustion fermé et s'en forge une position de tout premier plan en Europe. Des autres innovations au fil des années sont le Step Burner®, l'effet Opti-myst unique et l'expérience de feu Opti-Virtual®. Nouveau est l'App C.T.I., une application qui vous permet de contrôler votre foyer par votre portable ou tablette tactile, de profiter d'un beau jeu de flammes et pourtant d'économiser jusqu'à 70% sur votre consommation d'énergie. Dans ce brochure nous vous présentons notre gamme de foyers à gaz. Outre les foyers à gaz, vous trouverez une vaste gamme de foyers électriques et de poêles à bois Faber.

Laissons-nous vous inspirer!

02 On fire since 1844  
04/05 Technical details  
06/07 I.T.C. app

## Gas fires

### Built-in

08/09 4Seasons Premium  
10/11 Fyn 450 / 600  
12/13 Relaxed Premium M / L / XL  
14/15 Straight  
16/17 Triple Premium M / L / XL / XXL

### Built-in room divider

18/19 Aspect Premium C L  
20/21 Aspect Premium ST L / XL  
22/23 Aspect Premium RD L / XL  
24/25 Bright  
26/27 Glance

### Built-in corner

28/29 Duet Premium M / L / XL  
30/31 Honest  
32/33 Solution Premium  
34/35 Respect Premium IC  
36/37 Respect Premium OC

### With surround

38/39 Clear / Wirdum 840  
40/41 Hestia / Wirdum 670  
42/43 Spectra frameless / Wirdum 840

### Free-standing

44/45 Farum  
46/47 Jelling  
48/49 Odense  
50/51 Skive  
52/53 Vaska

### Outdoor fires

56/57 theBUZZ  
58/59 theMOOD  
60/61 theTUBE  
62 SketchUp  
63 Technical Icons



**NL Mag ik mij even voorstellen?**

"Fabio is mijn naam, ik ben uw persoonlijke stook-assistent, ik adviseer en geef handige tips". Bij vragen... vraag Fabio. Faber investeert veel tijd in onderzoek en ontwikkeling van het ultieme vlammenspel. Met deze investering hebben we een 4-tal speciaal gepatenteerde gasbranders ontwikkeld.

- **De Log Burner®**

Met de Log Burner® komen de vlammen uit de keramische houtstammen, deze brander geeft de meest realistische 'houtvuur' beleving die mogelijk is.

- **De Flat Burner®**

Mode bepaalt het beeld in kleding, interieur maar ook in haardontwerpen. De Flatburner® maakt het mogelijk door zijn compacte bouwwijze en ongelimiteerde vorm mogelijkheden haarden in de meest uiteenlopende vormen te ontwikkelen!

- **De Emberbed Burner®**

Out of the box, eenvoudig maar krachtig zijn woorden die de essentie van dit brander ontwerp beschrijven. Door een slim gebruik van een gebogen buisbrander is Faber er in geslaagd hiermee een verrassend vuur te creëren.

**E Allow me to introduce myself...**

"My name is Fabio, I am your personal heating assistant, I will give advice and clever tips". For questions... ask Fabio. Faber spends a lot of time on research and the development of the ultimate flame illusion. Due to this investment we have developed some four specially patented gas burners.

- **The Log Burner®**

The Log Burner® shows the flames emanating from the ceramic logs; this burner provides the most realistically possible 'wood fire' illusion.

- **The Flat Burner®**

Fashion determines the image in dress and furniture but also in fireplace designs. The Flat burner®, due to its compact construction method and unlimited shape, makes it possible to design fires in the most diverse forms!

- **The Ember bed Burner®**

Out of the box, simple but powerful, are words to describe the essence of this type of burner design. By a clever design of the bent tube burner Faber has managed to create a surprising fire. Of course you can vary the style of your fire to your heart's content.

**D Darf ich mich kurz vorstellen?**

"Fabio ist mein Name, ich bin Ihr persönlicher Assistent, ich berate Sie und gebe Ihnen praktische Tipps". Bei Fragen... Fabio fragen. Faber investiert viel Zeit in Forschung und Entwicklung des optimalen Flammenbildes. Mit dieser Investition haben wir vier spezielle, patentierte Gasbrenner entwickelt.

- **Der Log Burner®**

Mit dem Log Burner® steigen die Flammen aus keramischen Holzstämmen empor; dieser Brenner bringt ein 'Holzfeuer'-Erlebnis, was man sich naturgetreuer nicht vorstellen kann.

- **Der Flat Burner®**

Der Flatburner® ermöglicht durch seine kompakte Bauweise und unlimitierte Form die Entwicklung von Gaskaminen in den unterschiedlichsten Formen!

- **Der Emberbed Burner®**

Out-of-the-box, einfach, aber kräftig - diese Wörter beschreiben das Wesentliche dieses Brennerentwurfs. Durch eine clevere Nutzung eines gebogenen Rohrbrenners ist es Faber gelungen, ein überraschendes Feuer zu kreieren. Natürlich können Sie auch hier den Kaminstil nach Herzenslust variieren.

**F Je me présente :**

"Je m'appelle Fabio, votre assistant chauffage personnel ! Je vous informe et vous donne des conseils pratiques". Questions... Posez-les à Fabio!

Faber investit beaucoup dans la recherche et le développement du jeu de flammes ultimes. Cet investissement a mené à quatre brûleurs patentés spéciaux.

- **Le Log Burner®**

Au Log Burner® les flammes se répartissent du jeu de bois céramique. Ce brûleur donne l'impression de feu de bois le plus réaliste possible.

- **Le Flat Burner®**

La mode inspire les vêtements, l'intérieur mais aussi les dessins des foyers. Le Flatburner® permet, par son type de construction et forme illimité, de développer des foyers des formes les plus divers possibles!

- **Le Emberbed Burner®**

"Out of the box", "simple mais vigoureux" sont des mots qui décrivent l'essence de ce type de brûleur. À cause de l'usage ingénieusement d'un brûleur de buse, Faber a succédé en créant un feu étonnant. Bien évidemment vous en pouvez aussi varié le style de foyer.



**NL De Step Burner®**

De Faber Step Burner® is de meest revolutionaire gasbrander beschikbaar op de markt! De door Faber ontwikkelde Step Burner® is een gasbrander die op een unieke manier regelbaar is. Bij een volledig vermogen zijn de vlammen over de volle breedte van de haard te zien. Maar wanneer er minder warmte wordt gevraagd, concentreert het vuur zich in het midden van de brander. Nog een stapje terug worden deze vlammen kleiner, maar geven nog steeds het beeld van een sfeer vol brandend haardvuur. Nieuw is de schakelfunctie in de eco besturing. Dit heeft men ECOboost genoemd. Faber heeft het beste van beide werelden gecombineerd: een schakelbare Stepburner® met een continu regelende besturing. In een opeenvolgend programma kan het gasverbruik met tot wel 70% worden gereduceerd.

**E The Step Burner®**

The Faber Step Burner® is the most revolutionary burner available on the market! The Step Burner® developed by Faber is a gas burner that is uniquely adjustable. At full power the flames are visible along the entire length of the fire. But when less heat is requested, the fire will be concentrated in the centre of the burner. Another step back, the flames will grow smaller, but still provide the illusion of an atmospherically burning fire. New is the switching function in the eco controls. This has been called ECO boost. Faber has combined the best of both worlds: a Step burner® that can be switched off with continuous controls. In a sequential programme the use of gas can be reduced by up to 70%.

**D Der Step Burner®**

Der Faber Step Burner® ist der revolutionärste Gasbrenner, der am Markt erhältlich ist! Der von Faber entwickelte Step Burner® ist ein Gasbrenner, der auf einmalige Weise regelbar ist. Bei Volleistung sind die Flammen über die gesamte Kaminbreite sichtbar. Wenn weniger Wärme gewünscht ist, konzentriert sich das Feuer in der Mitte des Brenners. Noch einen Schritt zurück werden die Flammen kleiner, aber zeigen immer noch das Bild eines stimmungsvoll brennenden Kaminfeuers. Neu ist die Schaltfunktion der ECO-Steuerung. Sie hat den Namen ECO-Boost erhalten. Faber hat das Beste beider Welten kombiniert: ein ausschaltbarer Stepburner® mit einer kontinuierlich regelnden Steuerung. In einem ansteigenden Programm kann der Gasverbrauch um zu 70% reduziert werden!

**F Le Step Burner®**

Le Step Burner® du Faber est le brûleur à gaz le plus révolutionnaire que le marché a à offrir. Avec le Step Burner® Faber a mis au point un brûleur à gaz avec un système de réglage unique. Dans la position maximum les flammes se répartissent sur toute la largeur du foyer. Quand moins de chaleur est demandée, le feu se concentre autour du brûleur. En diminuant encore une position la hauteur des flammes diminuera, mais l'ambiance du feu sera toujours garantie. Nouveau est le système de réglage en commande Eco, appelé ECOboost. Faber a combiné le meilleur de deux mondes: un Stepburner déclenchable avec une commande réglant continue: dans un programme montant la consommation de gaz peut être réduit jusqu'à 70%.

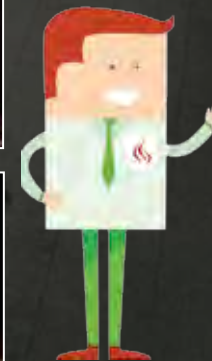

- NL** Bespaar met de Step Burner Ecoboost tot 70% op uw verbruik!
- E** Save up to 70% in energy with the Step Burner Ecoboost!
- D** Spare bis zu 70% beim Verbrauch mit der Step Burner Ecoboost!
- F** Économisez jusqu'à 70% sur votre consommation de gaz avec le Step Burner Ecoboost!



#### **NL Comfort en milieu gaan hand in hand anno 2014**

Faber introduceert de Intelligent Technical Control App. Gas is een schone brandstof en met de moderne technieken ook regeneratief! Dus milieuvriendelijk. We willen deze brandstof natuurlijk zo efficiënt mogelijk inzetten. Hiervoor introduceert Faber de Intelligent Technical Control. Een besturingssysteem dat u de mogelijkheid geeft om van uw haard op efficiënte en sfeervolle manier te genieten. Om eenvoudig toegang te krijgen tot de bediening van dit systeem heeft Faber een moderne applicatie ontwikkeld, de ITC App. De Faber ITC App kunt u gratis downloaden in de App Store of via Google play. De App bestuurt, controleert, regisseert en adviseert.

**Besturen:** u kunt uw haard met uw smartphone/tablet binnen het wifi bereik bedienen. Op deze manier heeft u volledig controle over uw haard. Wanneer het te warm wordt zet u de haard eenvoudig lager met de afstandsbediening, telefoon of tablet. Dit kan door middel van bijvoorbeeld de thermostaat functie, voor een constante temperatuur. De handmatige functie voor het kiezen van uw warmte wens. Met de Eco functie kunt u kiezen voor een modulerend vlammenbeeld waarmee u, in een olopend programma tot 70% kan besparen op uw verbruik!

**Controleren:** tijdens het gebruik gebeurt er van alles in uw haard. Veel van deze zaken worden via sensoren gemeten en gecontroleerd door de I.T.C. app. De App slaat deze informatie op zodat u een compleet overzicht heeft van uw haard en een monteur bij een storing een goede analyse kan maken.

**Regisseren:** in de statistieken is het gebruik overzichtelijk weergegeven van het aantal uren dat de brander ingeschakeld is geweest tot een evt. aard van de storing.

**Adviseren:** de app geeft gedetailleerde informatie over haard, dealer en fabrikant. Met één druk op de knop kunt u uw dealer E-mailen of bellen, uw gegevens wijzigen en gebruikersinformatie opvragen.

Faber heeft een applicatie welke op een eigen I.T.C. platform werkt. Mocht u al een aantal jaren genieten van uw Faber haard, dan kan op uw haard waarschijnlijk in vele gevallen de I.T.C. alsnog worden toegevoegd. De ITC app geeft Faber tevens de mogelijkheid om uw bedieningsgemak en de informatie voorziening te upgraden. Alle informatie over de App vindt u op [www.app.faber.nl](http://www.app.faber.nl)

Faber biedt u het totaal pakket! Faber, niet voor niets marktleider in haarden!

#### **E Comfort and sustainability go hand in hand in the year 2014.**

Faber is introducing the Intelligent Technical Control App. Gas is a clean fuel and also regenerative due to modern techniques. So it is sustainable. Of course we would like to use this fuel in the most efficient way. That is

why Faber is introducing the Intelligent Technical Control. A control system that will allow you to manage your fire efficiently and attractively. In order to gain simple access to this system, Faber has developed an up-to-date application, the I.T.C. App. The Faber I.T.C. App can be freely downloaded in the App store or in Google Play. The App controls, checks, manages and advises.

**Controlling:** You can manage your fire by means of your smart phone / tablet within Wi-Fi range. In this way you can exert complete control over your fire. If it is getting too hot, you can simply switch it to a lower setting by means of your remote control, your phone or tablet. This can be done e.g. by using the thermostat function for a constant temperature. The manual function for choosing your preferred heat level. By means of the Eco function you can choose the modulating fire image which will allow you to save up to 70% in energy use in a sequential programme!

**Checking:** while the fire is switched on, a lot may happen. Many of these things are measured by means of sensors and checked by your I.T.C. App. The App will store this information so that you will have a complete review of your fire and a mechanic can make a correct analysis of the problem in case of a malfunction.

**Managing:** the statistics show a clear picture of the number of hours the fire has been switched on as well as the possible nature of the malfunction.

**Advising:** the app will supply detailed information about the fire, the dealer and the manufacturer. With one touch you can E-mail or call your dealer, change your personal data and request user information.

Faber has an application that works on its own I.T.C. interface. If you have enjoyed the use of your fire for several years already, the I.T.C. can probably in many cases be added to your fire. The I.T.C. App will also allow Faber to upgrade your controls and the supply of information.

Faber is offering you the total package! Faber, not for nothing the market leader in fires!

#### **D Komfort und Umwelt gehen anno 2014 Hand in Hand**

Faber führt die Intelligent Technical Control App ein. Gas ist ein sauberer Brennstoff und mit den modernen Techniken auch regenerativ!

Mithin umweltfreundlich. Wir möchten diesen Brennstoff natürlich möglichst effizient einsetzen. Dafür führt Faber die Intelligent Technical Control App ein. Eine Steuerung, die es Ihnen ermöglicht, Ihren Kamin auf effiziente und stimmungsvolle Weise zu genießen. Um einfachen Zugang zur Bedienung dieses Systems zu erhalten, hat Faber ein modernes Anwendungsprogramm entwickelt, die ITC App. Die Faber ITC-App

können Sie kostenlos im App Store oder über Google Play herunterladen. Die App steuert, kontrolliert, registriert und berät.

**Steuern:** Sie können Ihren Kamin mit Ihrem Smartphone/Tablet im WLAN-Bereich steuern. Auf diese Weise haben Sie die volle Kontrolle über Ihren Kamin.

Wenn es zu warm wird, stellen Sie den Kamin einfach mit der Fernbedienung, dem Smartphone oder Tablet niedriger. Das ist beispielsweise mit der Thermostat-Funktion für eine konstante Temperatur möglich. Die manuelle Funktion dient zur Wahl Ihres Wärmewunsches. Mit der Öko-Funktion können Sie sich für ein modulierendes Flammenbild entscheiden, mit dem Sie in einem ansteigenden Programm bis zu 70% beim Verbrauch sparen können!

**Kontrollieren:** Während der Benutzung passiert allerhand in Ihrem Kamin. Viele dieser Dinge werden über Sensoren gemessen und von der I.T.C. App kontrolliert. Die App speichert die Information, so dass Sie eine komplette Übersicht über Ihren Kamin haben und ein Techniker eine eventuelle Störung schnell und exakt analysieren kann. Registrieren In den Statistiken werden die Nutzung sowie die Zahl der Stunden, in denen der Brenner eingeschaltet war, bis hin zur Art einer eventuellen Störung übersichtlich dargestellt.

**Beratung:** Die App bietet detaillierte Informationen über Kamin, Händler und Hersteller. Mit einem Tastendruck können Sie Ihren Händler mailen oder anrufen, Ihre Daten ändern und Benutzerinformationen anfordern.

Faber hat ein Anwendungsprogramm, das auf einer eigenen I.T.C.-Plattform läuft. Sollten Sie bereits einige Jahre Ihren Faber-Kamin genießen, kann Ihr Kamin wahrscheinlich / in vielen Fällen mit dem I.T.C. nachgerüstet werden. Die ITC App gibt Faber zudem die Möglichkeit, die Bedienerfreundlichkeit und die Unterstützung durch Informationen aufzurüsten. Faber bietet Ihnen das Gesamtpaket! Faber, nicht umsonst Marktführer bei Kaminen!

#### **Ⓢ Confort en environnement vont main dans la main en 2014**

Faber introduit l'App de Control Technologique Intelligent. Gaz est un combustible propre et avec les techniques modernes même régénératif. Donc écologique. Bien évidemment nous voudrions utilisé ce combustible le plus efficace possible. Pour ce faire Faber introduit le Contrôle Technologique Intelligent. Un système de commande qui vous permet de profiter de façon efficace et en plein d'ambiance. Pour simplement accéder à ce système, Faber a développé une application moderne, l'App CTI. Vous pouvez télécharger l'App CTI gratuitement au App Store ou au

Google Play. L'Application Commande, contrôle, enregistre et conseille. Actionner: vous pouvez commander votre foyer avec un Smartphone ou tablette tactile dans la portée de votre réseau Wifi. De cette façon vous avez le contrôle totale de votre foyer.

Quand la température est trop élevée vous pouvez la faire descendre facilement avec la télécommande, portable ou tablette tactile. Vous pouvez le faire en utilisant la fonctionnalité du thermostat, pour une température constante. La fonctionnalité manuelle pour sélectionner la chaleur désirée. Avec la fonctionnalité Eco, vous pouvez choisir le jeu de flammes modulant, qui vous permet d'économiser, dans un programme montant, jusqu'au 70% de votre consommation de gaz.

**Contrôler:** en service, tant d'activités se déroulent. La plupart est mesuré par des détecteurs et contrôlé par l'App C.T.I. Cette information est enregistrée par l'App C.T.I., pour vous présenter un résumé complet de votre foyer et en permettant le monteur en cas d'un problème technique, d'en faire une analyse exacte.

**Enregistrer:** les statistiques présentent clairement l'utilisation du foyer: les heures que le brûleur a été en service jusqu'à la cause d'un problème technique éventuel.

**Conseiller:** l'application donne de l'information détaillée sur le foyer, le revendeur et le fabricant. En enclenchant un seul bouton, vous pouvez envoyer un email ou téléphoner votre revendeur, changer vos coordonnées ou demander l'information d'utilisateur.

Faber présente une application qui fonctionne sur une plateforme CTI individuel. Si vous profiter déjà d'un beau foyer Faber depuis plusieurs années, il est probable que le CTI peut quand même être installé. L'app CTI permet à Faber de mettre à jour votre confort d'utilisation ou l'équipement d'information. Faber vous offre le paquet complet! Faber, pas sans raison le leader au marché de foyers!

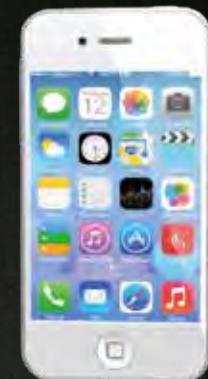

- Ⓝ Frameless inbouwhaard met glazen liftdeur  
De haard is zowel open als dicht te stoken.
- ⓔ Frameless built in fire with fully automatic glass fronted door. This unique fire can be used closed and open.
- ⓓ Rahmenloser Einbaukamin mit Glaslifttür.  
Der Kamin kann sowohl geöffnet auch geschlossen geheizt werden.
- ⓕ Foyer encastrable sans cadre avec porte vitrée soulevant. Le foyer s'allume avec la porte ouverte.





- Ⓝ 4Seasons Premium, de haard voor ieder seizoen!
- ⓔ 4Seasons Premium, the fire for any season!
- ⓓ 4Seasons Premium, der Kamin für jede Saison!
- ⓕ 4Seasons Premium, le foyer pour chaque saison!

# 4Seasons Premium

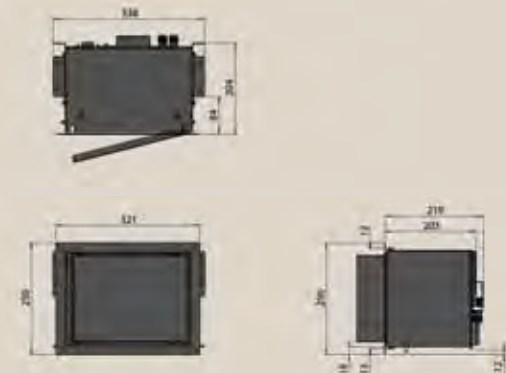

Assy Gas Valve Holder 4Seasons Premium



	Door open	Door closed
Input (kW)*	11.5 kW	11.5 kW
 Heat output (kW)*	2.9 kW	8.9 kW
 Heat output (kW)*	1.7 kW	5.0 kW
 Heat output (kW)*	1.2 kW	4.9 kW
 Heat output (kW)*	0.8 kW	2.8 kW

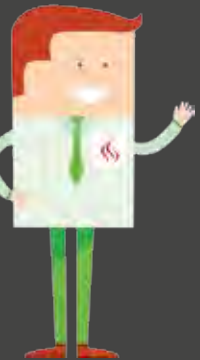



# 4Seasons Premium

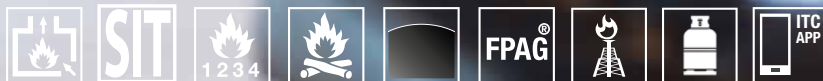

- Ⓝ Fyn serie:  
Frameless inbouwhaard in een portrait of landscape uitvoering.
- ⓔ Fyn series:  
Frameless built-in fire in a portrait or landscape design.
- ⓓ Fyn-Reihe:  
Rahmenloser Einbaukamin in einer Hochformat- oder Querformat-Ausführung.
- ⓕ Série Fyn:  
Foyer encastrable sans cadre, en version portrait ou landscape.

# Fyn 450 / 600



	Fyn 450	Fyn 600
Input (kW)*	4.5 kW	5.0 kW
Heat output (kW)*	3.2 kW	3.5 kW

Fyn 450 / 600



Built-in / 11

- Ⓝ Relaxed Premium serie:  
Moderne frameless inbouwhaard met innovatieve Step Burner® Ecoboost. In 3 formaten leverbaar.
- ⓔ Relaxed Premium series:  
Modern frameless built-in fire with innovative Step Burner® Ecoboost. Available in 3 sizes.
- Ⓧ Relaxed Premium-Reihe:  
Moderner, rahmenloser Einbaukamin mit innovativem Step Burner®-Ecoboost. In 3 Größen lieferbar.
- ⓕ Série Relaxed Premium:  
Foyer encastrable modern sans cadre avec le Step Burner® Ecoboost innovant. Disponible en trois tailles.

# Relaxed Premium M / L / XL

Relaxed Premium M







Relaxed Premium L

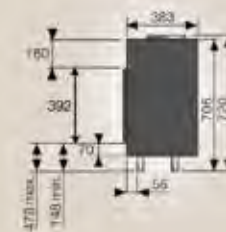
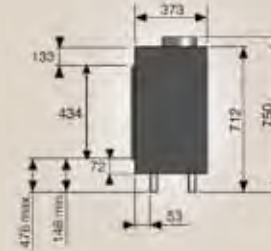
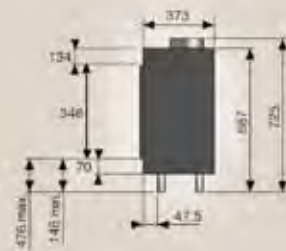

Relaxed Premium XL



	Relaxed Premium M	Relaxed Premium L	Relaxed Premium XL
Input (kW)*	7.9 kW	10.5 kW	12.0 kW
 Heat output (kW)*	5.5 kW	7.4 kW	8.4 kW
 Heat output (kW)*	2.3 kW	2.4 kW	3.1 kW
 Heat output (kW)*	3.0 kW	3.4 kW	4.6 kW
 Heat output (kW)*	1.7 kW	1.9 kW	2.4 kW



# Relaxed Premium M / L / XL

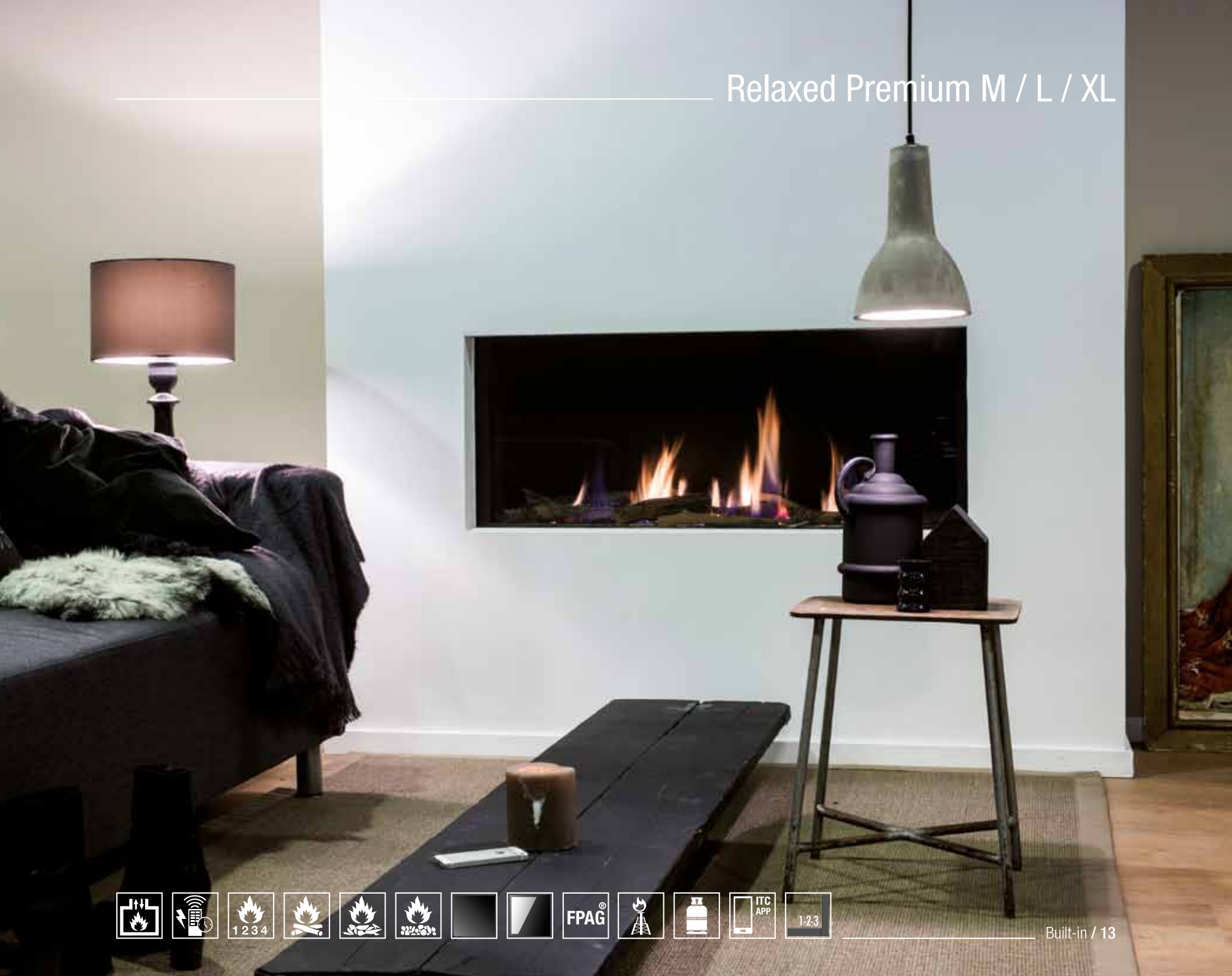

- Ⓝ Smalle hoge frameless inbouwhaard.
- ⓔ Narrow high frameless built-in fire.
- ⓓ Schmäler, hoher, rahmenloser Einbaukamin.
- ⓕ Foyer étroit et haut encastrable sans cadre.

## Straight Frameless



	Straight
Input (kW)*	7.2 kW
Heat output (kW)*	5.0 kW

# Straight Frameless



Ⓝ Triple Premium serie:  
Frameless 3-zijdige inbouw gashaard met  
innovatieve Step Burner® Ecoboost,  
leverbaar in 4 formaten.





ⓔ Triple Premium series:  
Frameless 3-sided built-in gas fire with innovative  
Step Burner® Ecoboost, available in 4 sizes.

ⓓ Triple Premium-Reihe:  
Rahmenloser, 3-seitiger Einbaukamin mit  
innovativem Step Burner®-Ecoboost, lieferbar in  
4 Größen.

ⓕ Série Triple Premium:  
Foyer encastrable à trois faces, sans cadre  
avec le Step Burner® Ecoboost innovant.  
Disponible en quatre tailles.

# Triple Premium M / L / XL / XXL



	Triple Premium M	Triple Premium L	Triple Premium XL	Triple Premium XXL
Input (kW)*	8.5 kW	10.5 kW	12.0 kW	14.5 kW
 Heat output (kW)*	6.2 kW	7.4 kW	8.4 kW	10.8 kW
 Heat output (kW)*	2.7 kW	4.0 kW	3.1 kW	5.1 kW
 Heat output (kW)*	3.3 kW	4.0 kW	4.6 kW	5.0 kW
 Heat output (kW)*	2.0 kW	3.0 kW	2.4 kW	2.7 kW





# Triple Premium M / L / XL / XXL

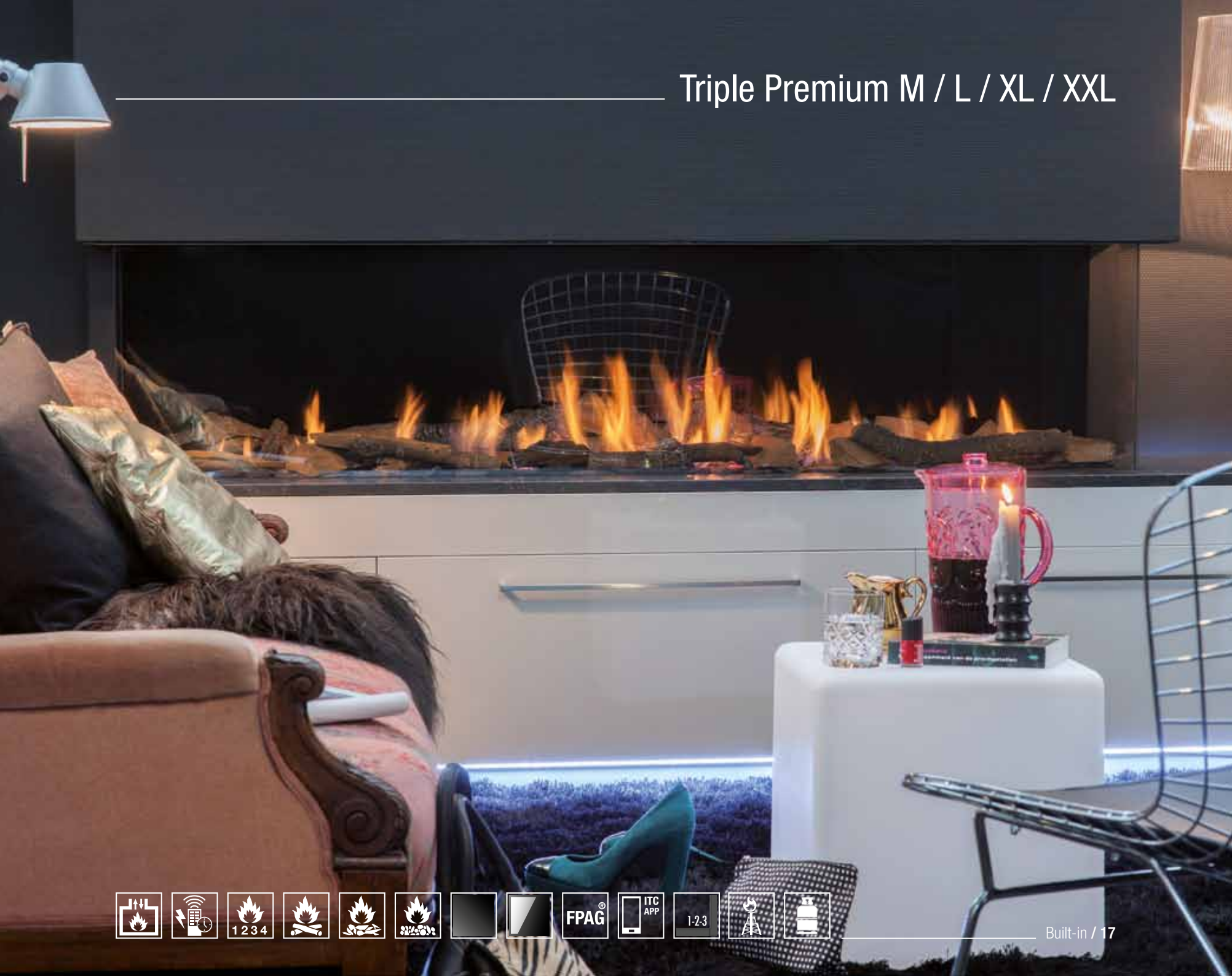





- Ⓝ Brede om-de-hoek haard, met innovatieve Step Burner® Ecoboost. Zowel links- als rechtszijdig leverbaar.
- Ⓔ Wide, outside-corner fire with innovative Step Burner® Ecoboost. Available both right and left sided.
- Ⓓ Rahmenloser, eckumgreifender Kamin mit innovativem Step Burner®-Ecoboost. Sowohl links- auch rechtsseitig lieferbar.
- Ⓕ Foyer extra large en coin, avec le Step Burner® Ecoboost innovant. Disponible en côté gauche et droit.

- Ⓝ Een doorkijkhaard is een haard (de naam zegt het al) waar je doorheen kunt kijken, ook wel tunnelhaard genoemd. Een doorkijkhaard wordt ook vaak als roomdivider gebruikt. Een centrale plaats is ideaal zodat je optimaal kan profiteren van een doorkijkhaard.
- Ⓔ A see-through fire (it is obvious from the name) is a fire that you can see through, also called a tunnel fire. A see-through fire is often used as a room-divider. A central position is ideal so you can take optimum advantage of a see-through fire.
- Ⓓ Ein Durchsichtkamin ist ein Kamin (der Name sagt es bereits), durch den man hindurchschauen kann, auch Tunnelkamin genannt. Ein Durchsichtkamin wird auch oft als Raumteiler verwendet. Ein zentraler Ort ist ideal, so dass man optimal von einem Durchsichtkamin profitieren kann.

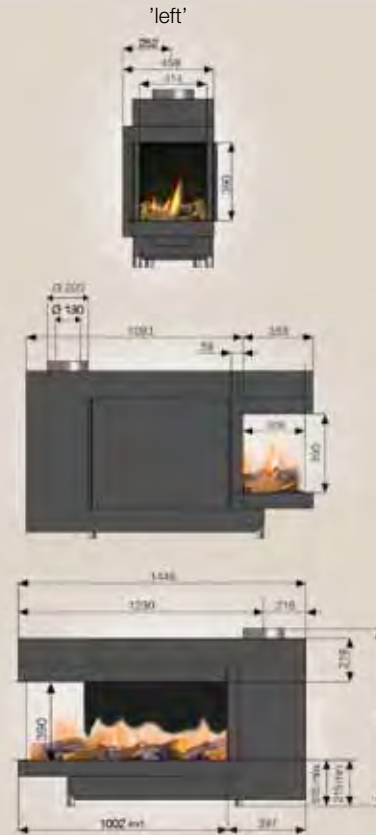
- Ⓕ Un foyer transparent est un foyer qui vous permet de voir d'un bout à l'autre, aussi connu comme foyer tunnel. En un foyer transparent le jeu de flammes est visible des deux côtés. Un endroit centrale en est idéal pour vous permettre de profiter au maximum de votre foyer transparent.

# Aspect Premium C L



Aspect Premium C L	
Input (kW)*	10.0 kW
 Heat output (kW)*	7.0 kW
 Heat output (kW)*	2.4 kW
 Heat output (kW)*	3.4 kW
 Heat output (kW)*	1.9 kW



# Aspect Premium C L

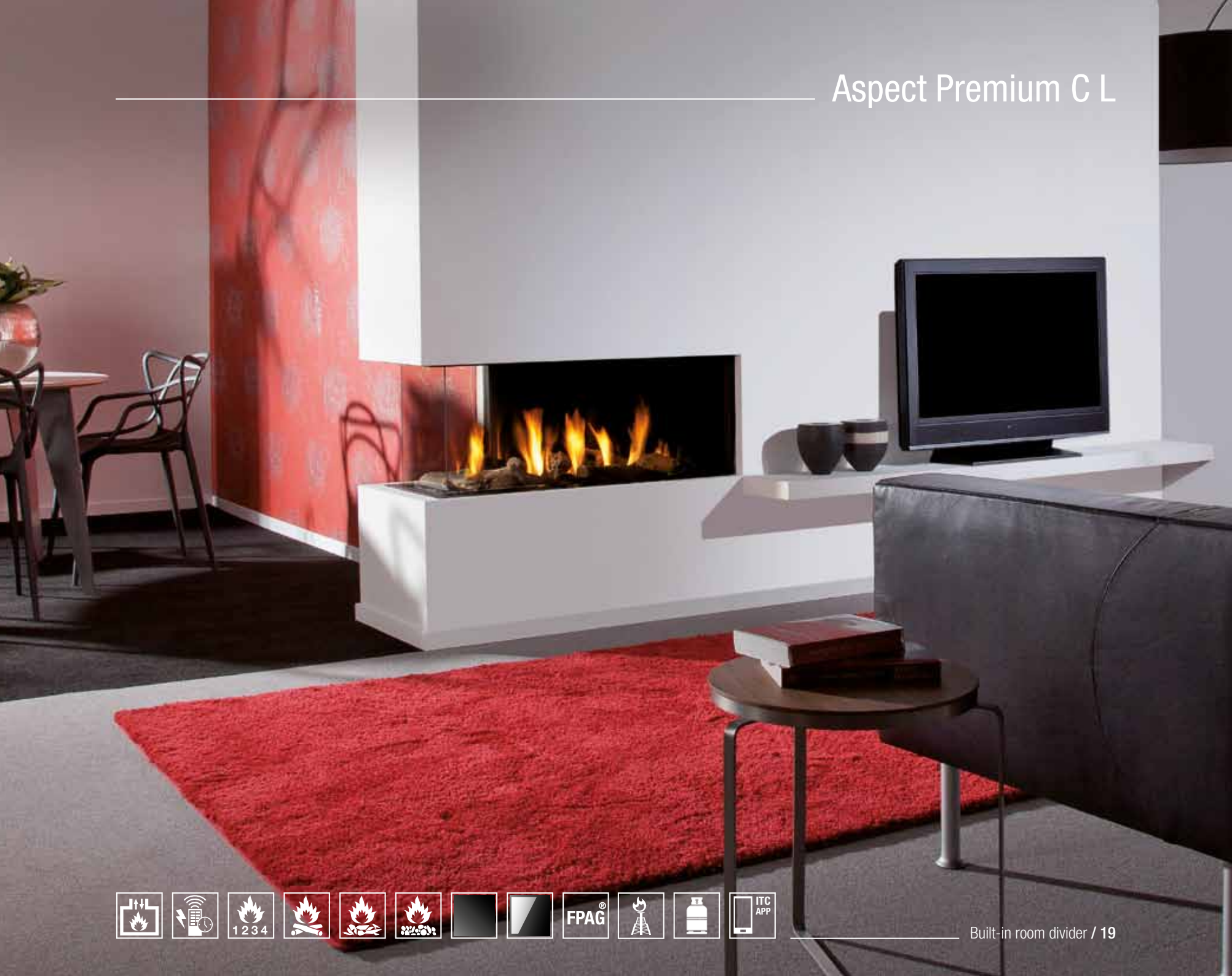

(NL) Aspect Premium serie:  
Strakke brede doorkijk gashaard, met innovatieve Step Burner® Ecoboost. In 2 formaten.

(E) Aspect Premium series:  
Taut wide see-through gas fire, with innovative Step Burner® Ecoboost. Available in 2 sizes.

(D) Aspect Premium-Reihe:  
Geradliniger, breiter Durchsichtkamin mit innovativem Step Burner®-Ecoboost.  
In 2 Größen lieferbar.

(F) Série Aspect Premium:  
Foyer transparent imposant, avec le Step Burner® Ecoboost innovant. Disponible en deux tailles.

(NL) Door de a-symmetrische constructie van deze haarden, afvoer rechts, zijn bijzonder ruimtelijk constructies mogelijk. Dit geldt voor alle haarden in de Aspect serie.

(E) Due to the a-symmetrical construction of these fires, with the flue on the right, very spacious structures are possible. This is true for all the fires in the Aspect series.

(D) Durch die asymmetrische Konstruktion dieser Kamine, Auslass rechts, sind außergewöhnliche räumliche Konstruktionen möglich. Dies gilt für alle Kamine in der Aspect-Reihe.

(F) Grâce à la construction asymétrique, conduit à droit, des constructions très spacieux sont possibles. Ceci est applicable pour tous les foyers du série Aspect.





# Aspect Premium ST L / XL

Aspect Premium ST L



Aspect Premium ST XL



	Aspect Premium ST L	Aspect Premium ST XL
Input (kW)*	10.0 kW	12.7 kW
 Heat output (kW)*	7.0 kW	8.9 kW
 Heat output (kW)*	2.4 kW	4.2 kW
 Heat output (kW)*	3.4 kW	5.0 kW
 Heat output (kW)*	1.9 kW	3.2 kW



# Aspect Premium ST L / XL

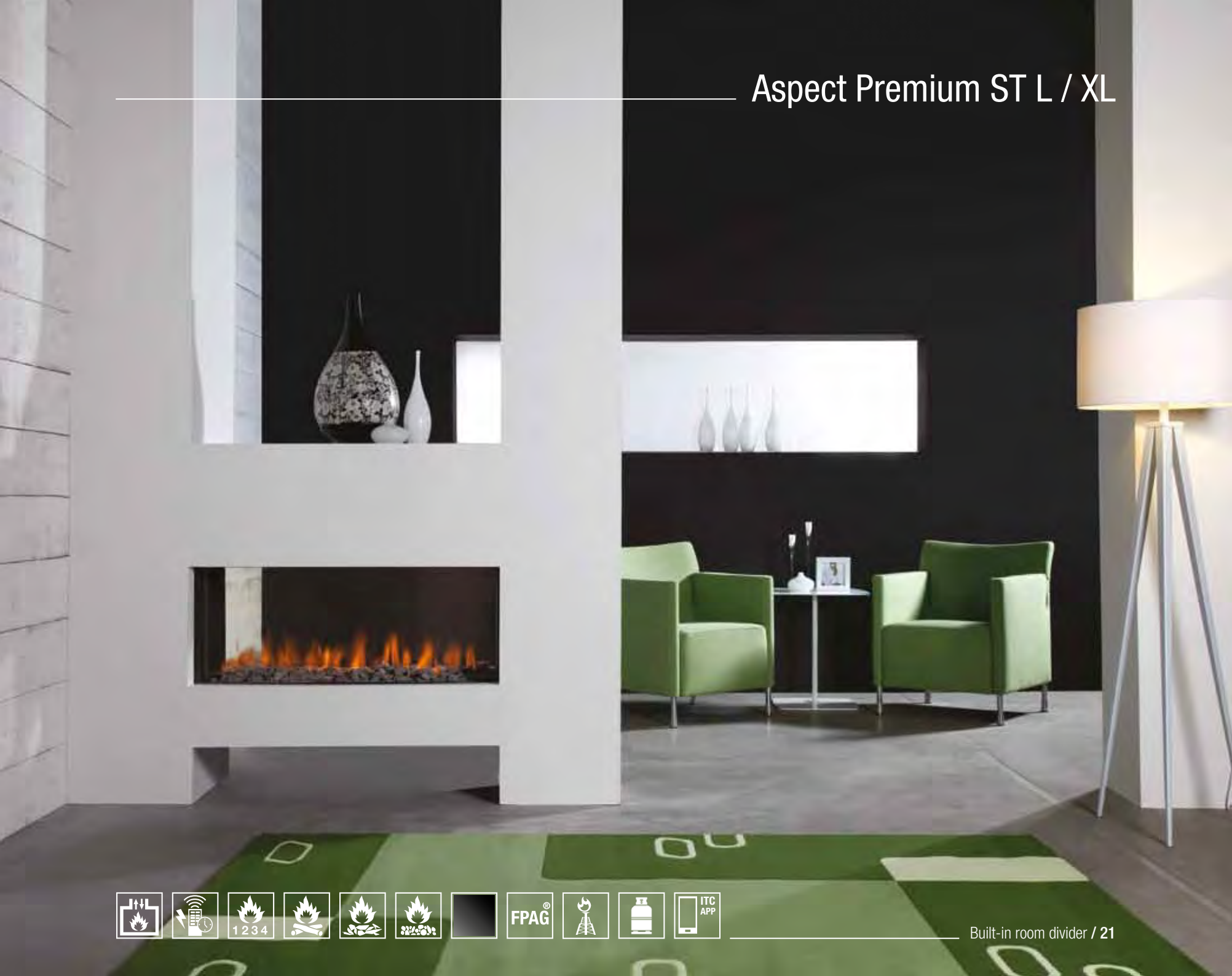

Ⓝ Aspect Premium serie:  
Brede 3-zijdige doorkijk gashaard,  
met innovatieve Step Burner® Ecoboost.  
In 2 formaten.

ⓔ Aspect Premium series:  
Wide 3-sided see-through fire with innovative  
Step Burner® Eco boost. Available in 2 sizes.

ⓓ Aspect Premium-Reihe:  
Breiter, 3-seitiger Durchsichtkamin mit  
innovativem Step Burner®-Ecoboost.  
In 2 Größen lieferbar.

ⓕ Série Aspect Premium:  
Foyer imposant à trois faces, Aspect Premium RD  
L / XL, avec le Step Burner® Ecoboost innovant.  
Disponible en deux tailles.





# Aspect Premium RD L / XL

Aspect Premium RD L

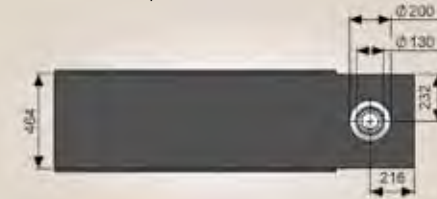

Aspect Premium RD XL



	Aspect Premium RD L	Aspect Premium RD XL
Input (kW)*	10.0 kW	12.7 kW
 Heat output (kW)*	7.0 kW	8.9 kW
 Heat output (kW)*	2.4 kW	4.2 kW
 Heat output (kW)*	3.4 kW	5.0 kW
 Heat output (kW)*	1.9 kW	3.2 kW



# Aspect Premium RD L / XL

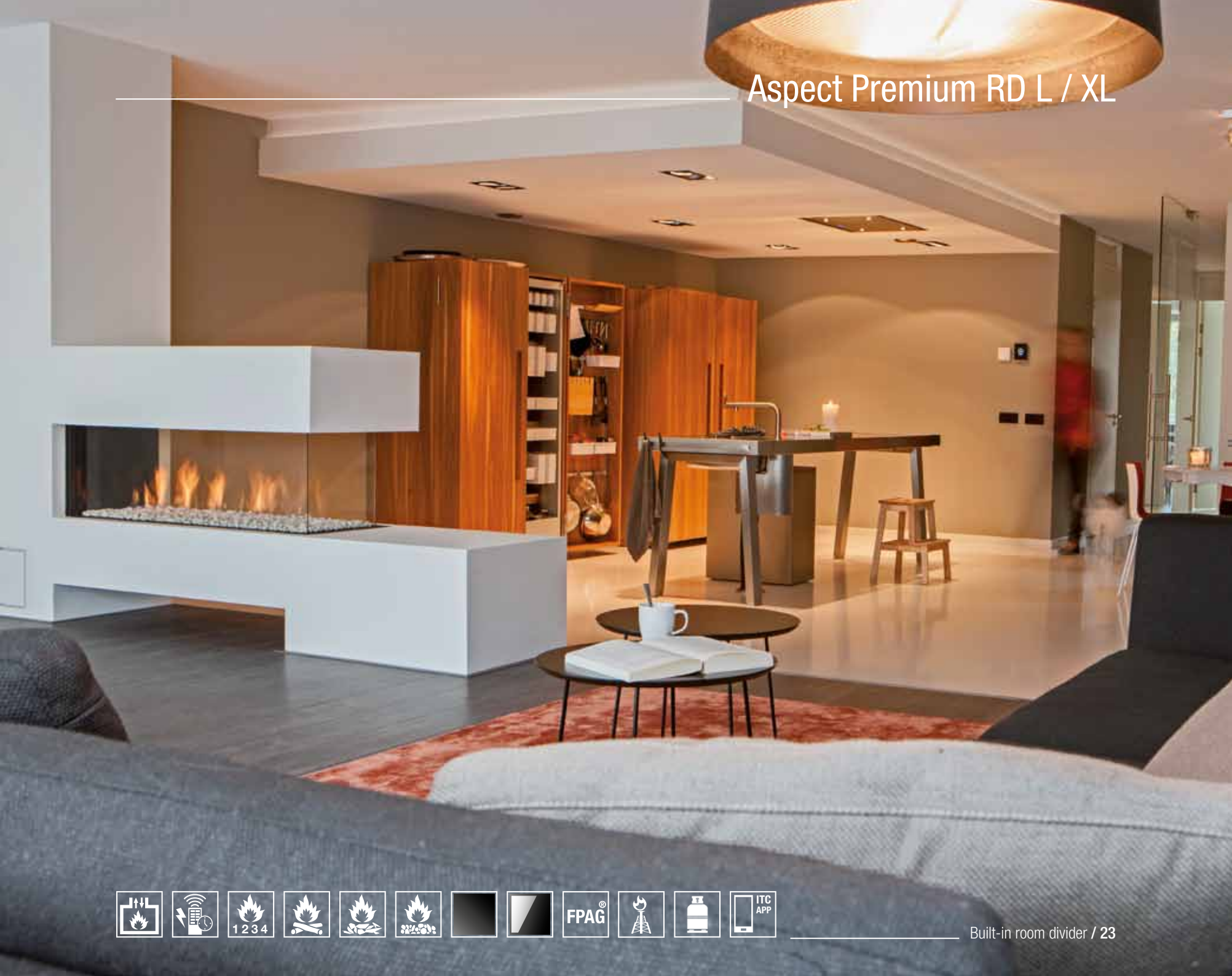

- Ⓝ Frameless doorkijkhaard.
- ⓔ Frameless see-through fire.
- Ⓧ 2-seitiger verglaster Kamineinsatz.
- ⓕ Foyer transparent encastrable.

# Bright

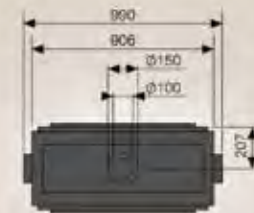

	Bright
Input (kW)*	8.7 kW
Heat output (kW)*	6.1 kW



Bright

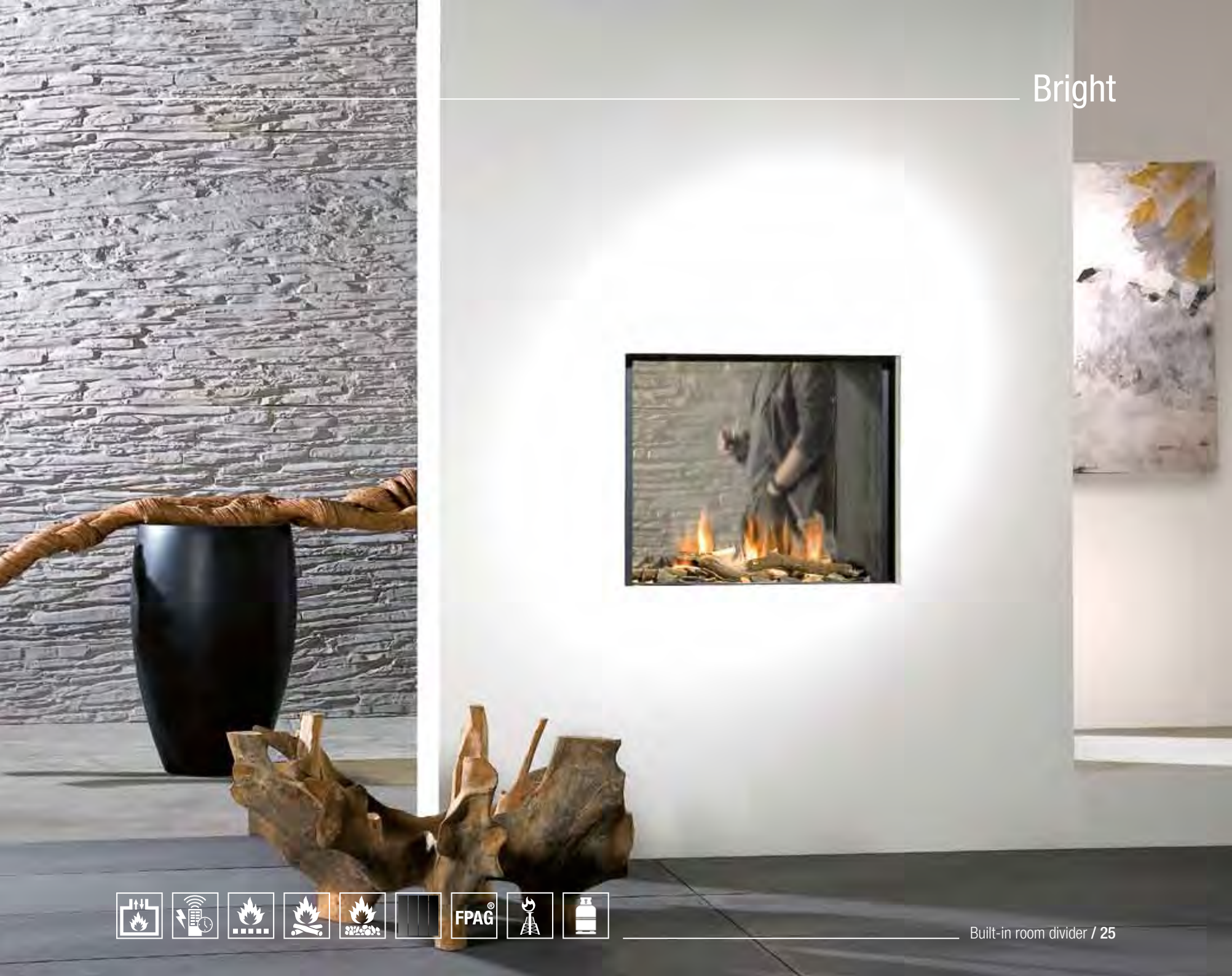

- Ⓝ Frameless doorkijkhaard.
- ⓔ Frameless see-through fire.
- Ⓣ 2-seitiger verglaster Kamineinsatz.
- ⓕ Foyer transparent encastrable.

# Glance

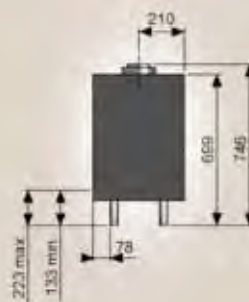

	Glance
Input (kW)*	8.8 kW
Heat output (kW)*	6.2 kW

# Glance

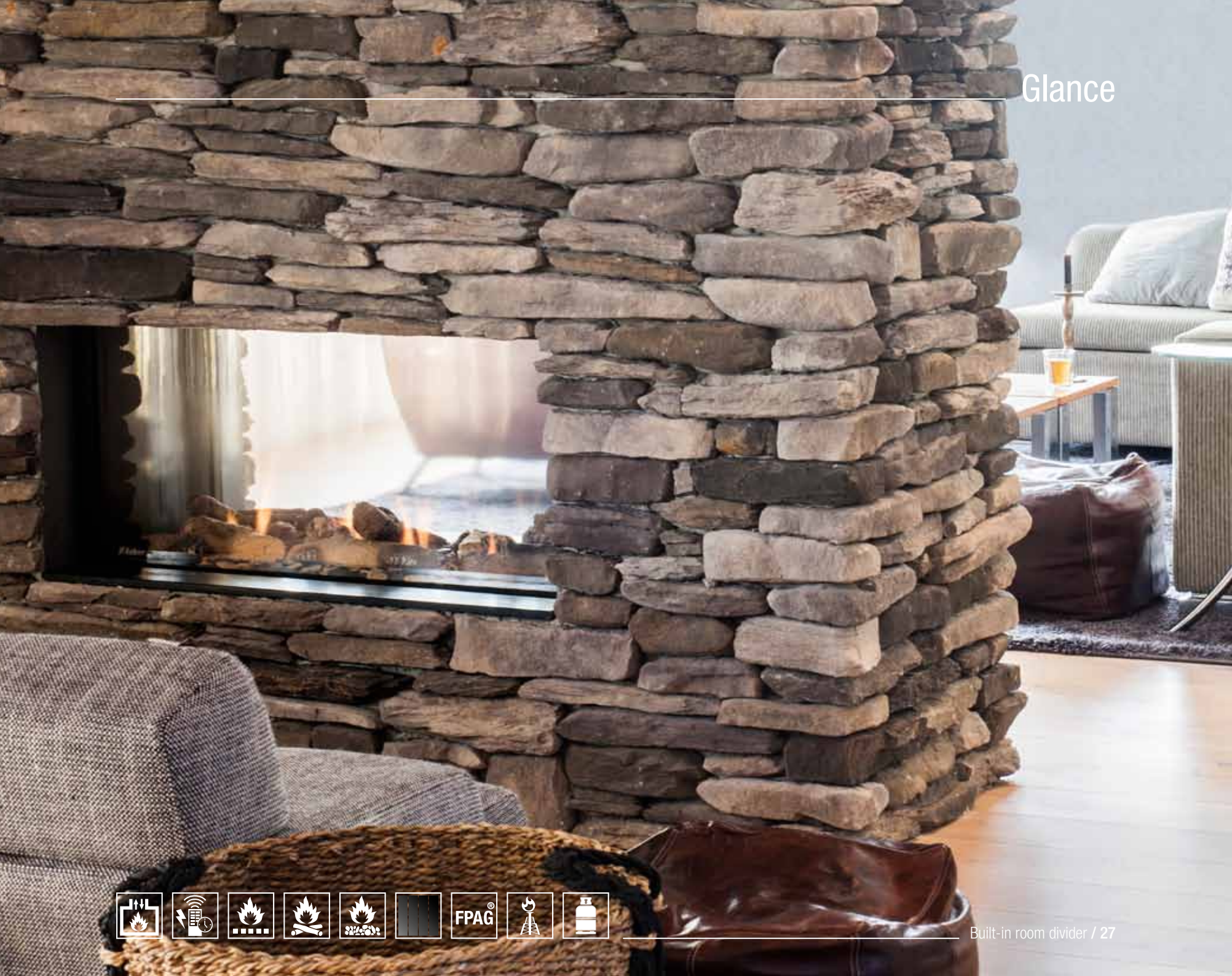

(NL) Duet Premium serie:  
2-zijdige inbouw hoekhaard met innovatieve Step Burner® Ecoboost. Zowel links- als rechtszijdig en in 3 formaten leverbaar.

(E) Duet Premium series: 2-sided built-in corner fire with innovative Step Burner® Eco boost.  
Available both left-sided and right-sided in 3 sizes.

(D) Duet Premium-Reihe: 2-seitiger Einbau-Eckkamin mit innovativem Step Burner®-Ecoboost.  
Sowohl links- auch rechtsseitig in 3 Größen lieferbar.

(F) Série Duet Premium:  
Foyer bilatéral, avec le Step Burner® Ecoboost innovant. Disponible en côté gauche ou droite. Disponible en trois tailles.

(NL) Deze serie is op 3 manieren in te bouwen:

- met plateau en afdekstrip.
- met plateau en inlegstrip.
- vlak in de wand met afdekstrip.

(E) This series can be built-in in three different ways:

- with plateau and cover strip.
- with plateau and insertion strip.
- close to the wall with a cover strip.

(D) Diese Reihe kann auf dreierlei Weise eingebaut werden:

- mit Plattform und Abdeckstreifen.
- mit Plattform und Einlegestreifen.
- wandbündig mit Abdeckstreifen .

(F) Ce série est encastrable de trois façons:

- avec plateau et strip de recouvrement.
- avec plateau et strip d'insert.
- dans un mur avec strip de recouvrement.



1-2-3

# Duet Premium M / L / XL

Duet Premium M

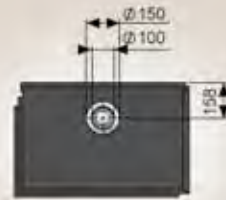

Duet Premium L



Duet Premium XL

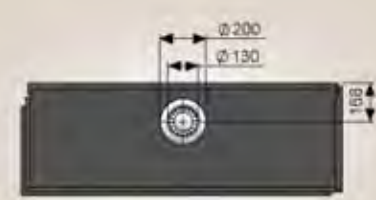

	Duet Premium M	Duet Premium L	Duet Premium XL
Input (kW)*	8.5 kW	10.5 kW	12.0 kW
 Heat output (kW)*	6.2 kW	7.4 kW	8.4 kW
 Heat output (kW)*	2.7 kW	4.0 kW	3.1 kW
 Heat output (kW)*	3.3 kW	4.0 kW	4.6 kW
 Heat output (kW)*	2.0 kW	3.0 kW	2.4 kW



# Duet Premium M / L / XL



- Ⓝ Een frameless hoekhaard met decoratieplaat, zowel links- als rechtszijdig plaatsbaar.
- ⓔ A frameless corner gas fire with decoration plate, usable for a left or right hand corner.
- ⓓ Eine rahmenlose Eckversion mit Zierplatte, sowohl links- als auch rechtsseitig lieferbar.
- ⓕ Foyer en angle sans cadre avec une plaque décorative.

- Ⓝ In huis wordt een hoek van een kamer relatief minder effectief benut. Maar voor een haard kan het juist een uitgelezen plek zijn. Faber heeft diverse hoekoplossingen.
- ⓔ Inside the home, the corners are less efficiently used. But for a fire it can be exactly the right place. Faber has various corner solutions.
- ⓓ Im Haus wird eine Ecke eines Zimmers relativ weniger effektiv genutzt. Aber für einen Kamin kann es gerade ein erlesener Ort sein. Faber hat verschiedene Ecklösungen.
- ⓕ Les coins d'une pièce sont rarement effectivement utilisés. L'ultime solution sera donc un foyer de coin, que vous trouverez en divers modèles chez Faber.



# Honest

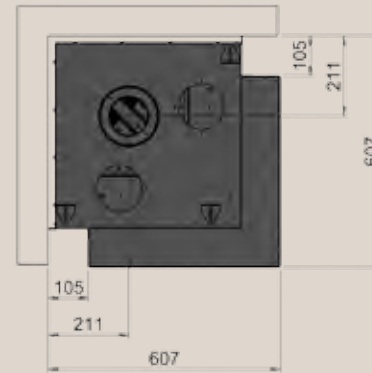

	Honest
Input (kW)*	7.0 kW
Heat output (kW)*	4.9 kW

Honest

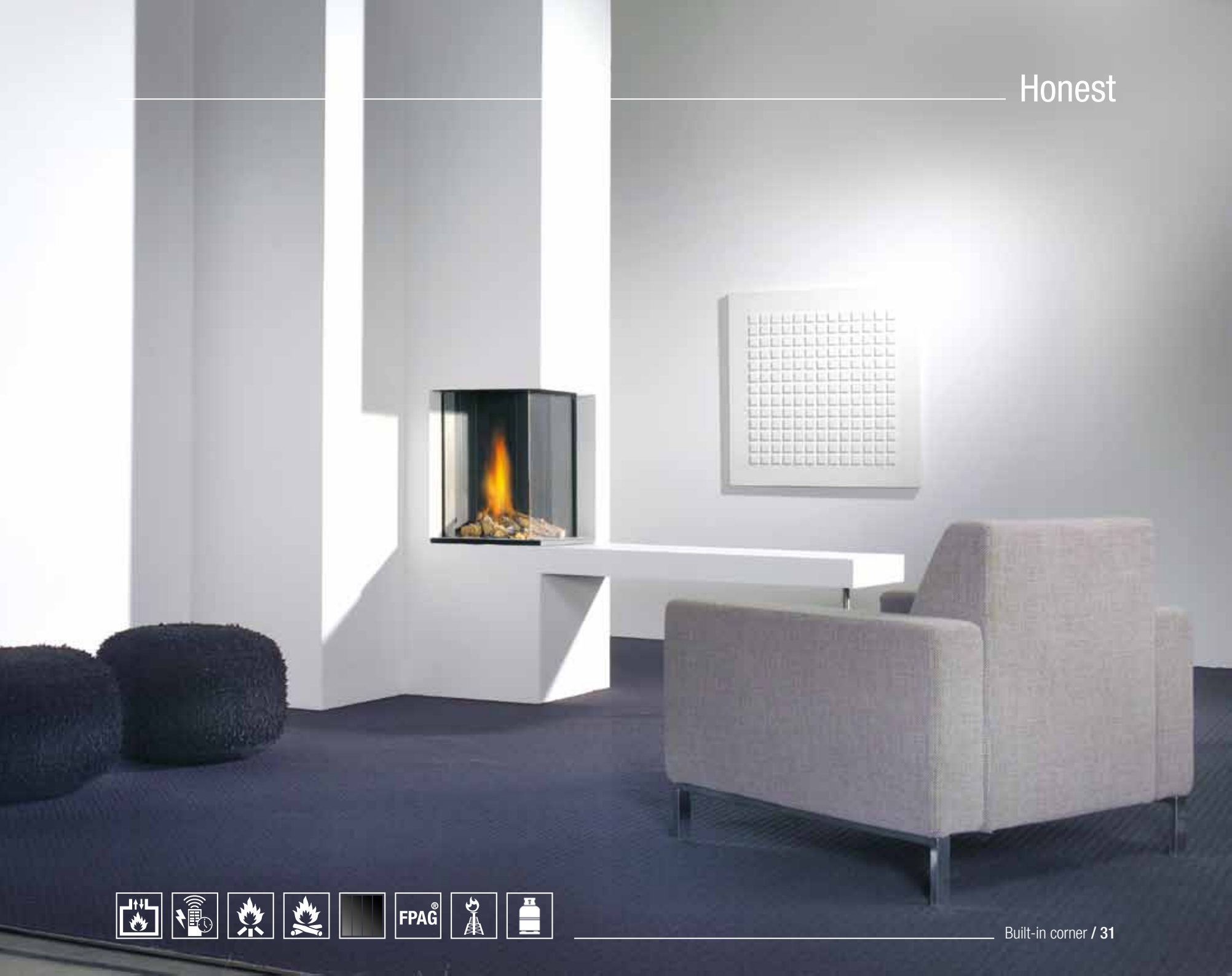





- Ⓝ Frameless hoekhaard, speciaal ontworpen om in een hoek geplaatst te worden zonder veel ruimte in beslag te nemen.
- ⓔ Frameless inside- corner fire, specifically designed to be placed in a corner without taking up a lot of space.
- ⓓ Rahmenloser Eckkamin, speziell entworfen, um einer Ecke aufgestellt zu werden, ohne viel Raum in Anspruch zu nehmen.
- ⓕ Foyer en angle sans cadres, conçu spécialement pour pouvoir s'encastrer dans chaque coin sans prendre beaucoup de place.

## Solution Premium



- Ⓝ Faber heeft een oplossing voor iedere hoek.
- ⓔ Faber has a solution for any corner.
- ⓓ Faber hat eine Lösung für jede Ecke.
- ⓕ Faber a une solution pour tout coin!



	Solution Premium
Input (kW)*	8.7 kW
 Heat output (kW)*	6.2 kW
 Heat output (kW)*	2.8 kW
 Heat output (kW)*	3.2 kW
 Heat output (kW)*	2.0 kW





# Solution Premium





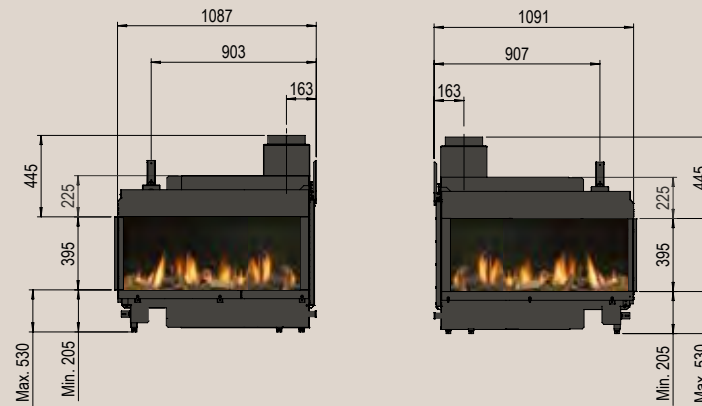
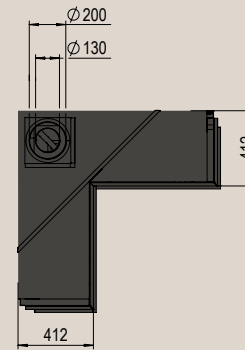

- (NL) Brede in de hoek haard.
- (E) Wide inside- corner fire.
- (D) Breiter Eckkamin.
- (F) Foyer dans coin unique, extra large

- (NL) De Respect IC kan in iedere willekeurige hoek worden geïnstalleerd. De Respect OC plaats je om een hoek heen. Dit laatste heeft als voordeel dat het brede vlammenbeeld vanuit een tweetal ruimtes zichtbaar is. Een haard in de hoek creëert daarentegen een intiem gevoel.
- (E) The Respect IC can be installed in any corner you prefer. The Respect OC can be placed on an outside corner. The latter has the advantage that the flames are visible from two different rooms. A fire in a corner, however, creates an intimate atmosphere.
- (D) Der Respect IC kann in jeder beliebigen Ecke installiert werden. Den Respect OC stellt man um eine Ecke herum. Letzteres hat den Vorteil, dass das breite Flammenbild von zwei Räumen aus sichtbar ist. Ein Kamin in der Ecke kreiert dagegen ein intimes Gefühl.
- (F) Le Respect IC peut être encastré dans chaque coin. Le Respect OC est installé en coin, ce qui vous permet de profiter du large jeu de flammes de deux pièces. Un foyer dans un coins crée cependant une sensation intime.

# Respect Premium IC



	Respect Premium IC
Input (kW)*	14.2 kW
 Heat output (kW)*	10.6 kW
 Heat output (kW)*	5.9 kW
 Heat output (kW)*	4.5 kW
 Heat output (kW)*	3.6 kW





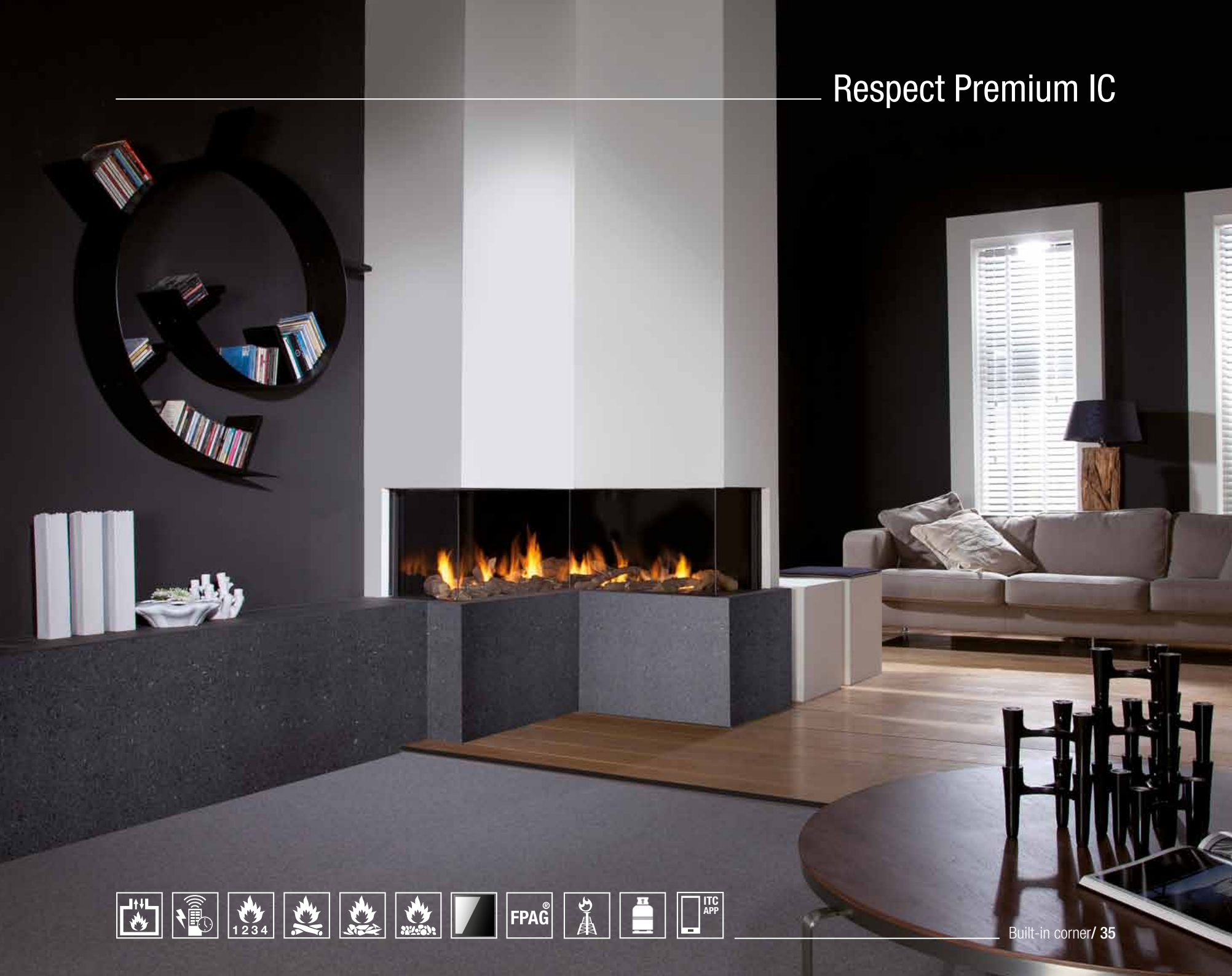

# Respect Premium IC

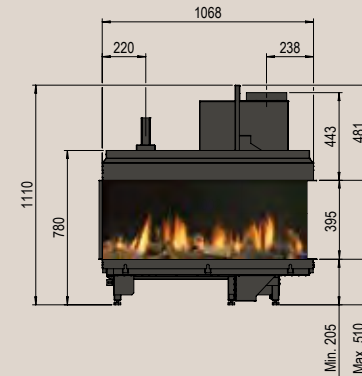
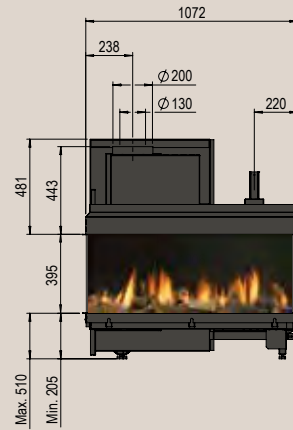
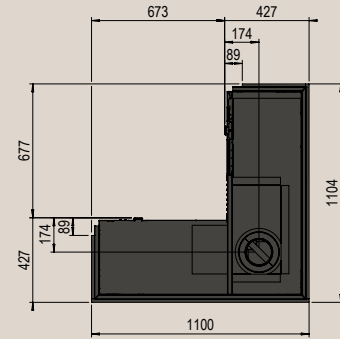

- Ⓝ Brede om de hoek haard.
- ⓔ Wide outside-corner fire.
- ⓓ Breiter Eckkamin.
- ⓕ Foyer en coin unique, extra large.

# Respect Premium OC



	Respect Premium OC
Input (kW)*	14.2 kW
 Heat output (kW)*	10.7 kW
 Heat output (kW)*	6.4 kW
 Heat output (kW)*	4.7 kW
 Heat output (kW)*	3.9 kW



# Respect Premium OC



- Ⓝ Frameless inbouwhaard.  
Ook mogelijk met schouw.
- Ⓔ Frameless built-in fire Clear.  
Also available with chimney breast.
- Ⓓ Rahmenloser Einbaukamin.  
Auch möglich mit Fassade.
- Ⓕ Foyer encastrable sans cadre.  
Clear Également disponible avec manteau.

# Clear

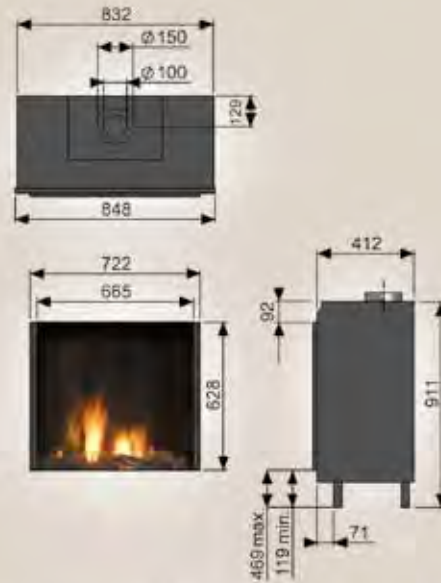

	Log Burner®	Flat Burner®
Input (kW)*	7.5	8.8
Heat output (kW)*	5.3	6.2

# Clear / Wirdum 840

Artificial Marble

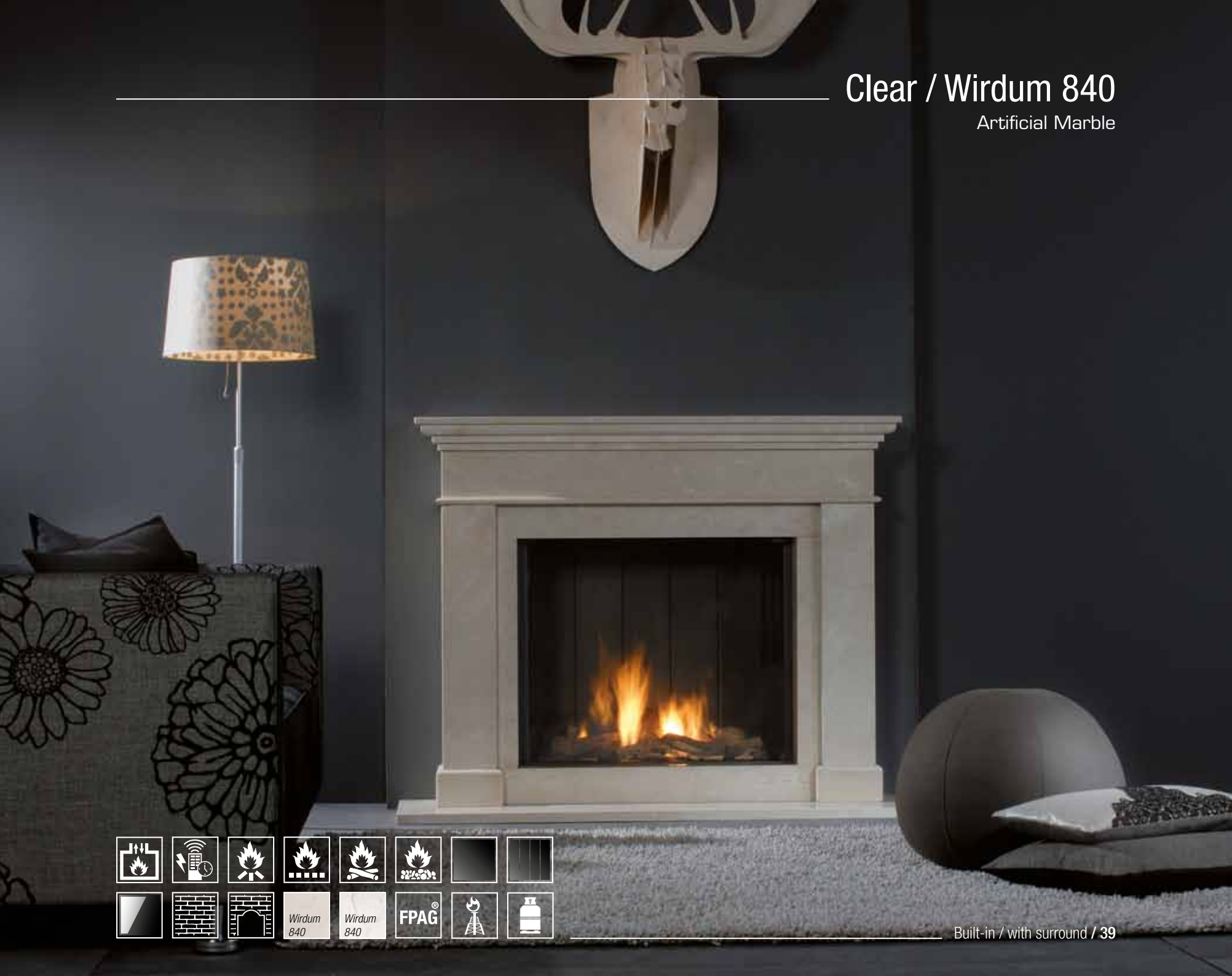

Wirdum  
840

Wirdum  
840

FPAG®

- Ⓝ Frameless inbouwhaard met zwarte dorpel.  
RVS dorpel is optioneel.  
Ook mogelijk met schouw.
- ⓔ Frameless built-in fire with black lintel.  
Stainless steel lintel is optional.  
Also available with chimney breast.
- ⓓ Rahmenloser Einbaukamin mit schwarzer Schwelle. Edelstahlschwelle ist optional.  
Auch möglich mit Fassade.
- ⓕ Foyer encastrable sans cadre en tiroir noir.  
Tiroir inox en option.  
Également disponible avec manteau.

# Hestia



	Log Burner®	Flat Burner®
Input (kW)*	7.5	8.8
Heat output (kW)*	5.3	6.2



# Hestia / Wirdum 670

Artificial Marble



Wirdum  
670

Wirdum  
670

FPAG®

Built-in / with surround / 41

- Ⓝ Frameless inbouwhaard met zwarte dorpel.  
RVS dorpel is optioneel.  
Ook mogelijk met schouw.
- ⓔ Frameless built-in fire with black lintel.  
Stainless steel lintel is optional.  
Also available with chimney breast.
- ⓓ Rahmenloser Einbaukamin mit schwarzer Schwelle. Edelstahlschwelle ist optional.  
Auch möglich mit Fassade.
- ⓕ Foyer encastrable sans cadre en tiroir noir.  
Tiroir inox en option.  
Également disponible avec manteau.

# Spectra Frameless



	Log Burner®	Flat Burner®
Input (kW)*	9.8	10.4
Heat output (kW)*	6.9	7.3

# Spectra Frameless / Wirdum 840

Artificial Marble



Built-in / with surround / 43

- Ⓝ Vrijstaande haard.
- ⓔ Free-standing gas fire.
- ⓓ Freistehender Kaminofen.
- ⓕ Foyer isolé.

- Ⓝ Uit onderzoek blijkt dat de samenstelling van aardgas geleidelijk zal veranderen. De gashaarden van Faber zijn voorzien van FPAG®-technologie (Future Proof – All Gasses). Dat betekent dat ze geschikt zijn voor alle nieuwe aardgasvarianten in de toekomst.
- ⓔ Research shows that the composition of natural gas will change gradually. Faber's gas fires have been supplied with FPAG®-technology (Future Proof – All Gasses). That means they are suitable for use with all new varieties of natural gas in the future.
- ⓓ Untersuchungen zeigen, dass sich die Zusammensetzung von Erdgas langsam ändern wird. Die Gaskamine von Faber sind mit FPAG®-Technologie (Future Proof - All Gasses) ausgestattet. Das bedeutet, dass sie für alle zukünftigen neuen Erdgasvarianten geeignet sind.
- ⓕ L'étude a montrée que la composition de gaz changera progressivement. Les foyer Faber sont équipé de la technologie FPAG® (Future Proof – All Gasses), ce qui veut dire qu'il seront adapté pour tout variant de gaz dans le futur.

# Farum



	Farum
Input (kW)*	4.5 kW
Heat output (kW)*	3.2 kW



# Farum



- Ⓝ Vrijstaande 3-zijdige haard in zwart gietijzer.
- ⓔ Free-standing 3-sided gas fire in black cast iron.
- ⓓ Freistehender 3-seitig verglaster Kaminofen in schwarzem Gusseisen.
- ⓕ Foyer isolé à trois faces en fonte noire.

# Jelling



	Jelling
Input (kW)*	6.5 kW
Heat output (kW)*	4.6 kW

# Jelling

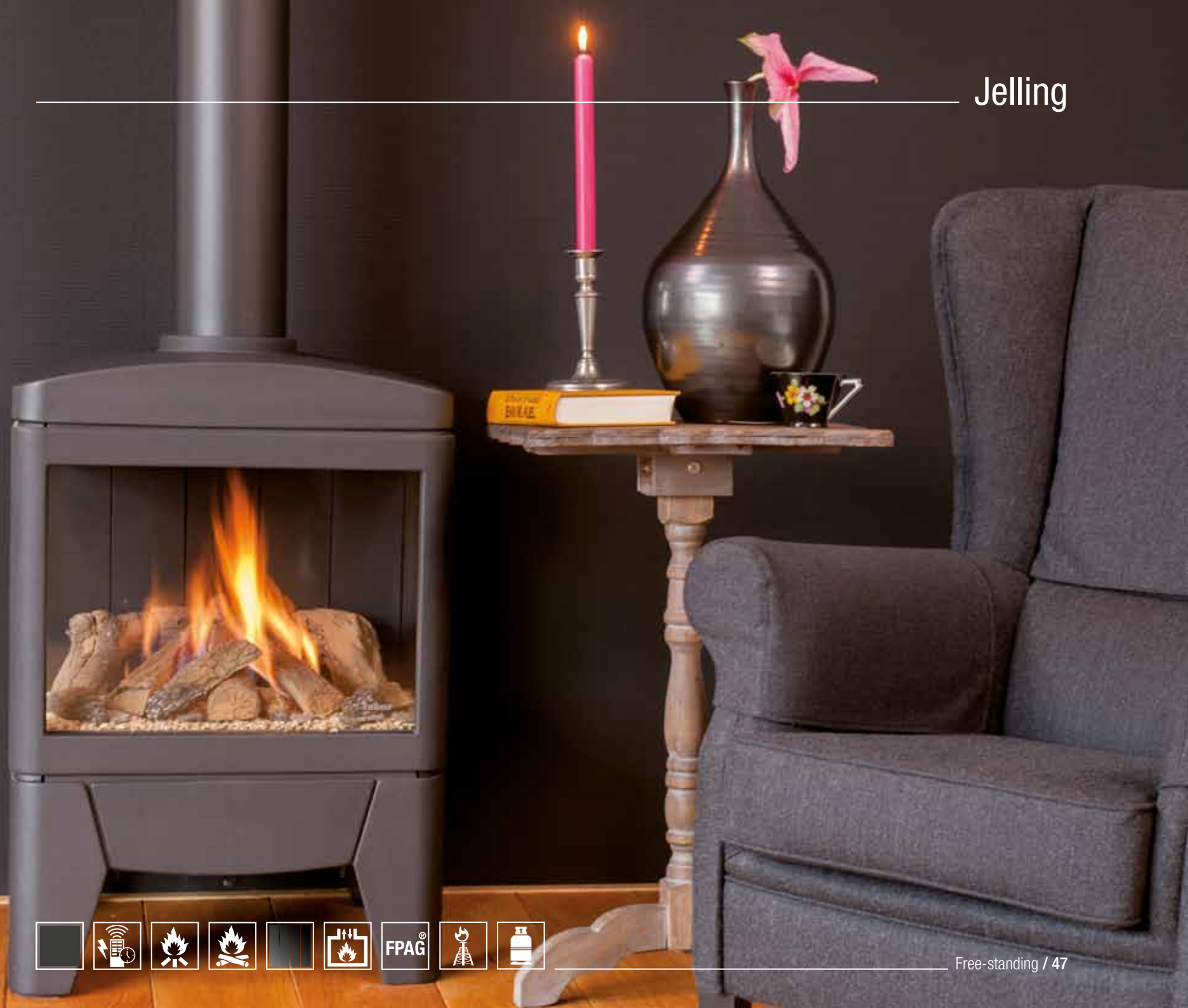

- Ⓝ Moderne vrijstaande 3-zijdige haard in zwart gietijzer.
- ⓔ Free-standing 3-sided gas fire in black cast iron.
- ⓓ Freistehender 3-seitig verglaster Kaminofen in schwarzem Gusseisen.
- ⓕ Foyer isolé à trois faces en fonte noire.

# Odense



	Odense
Input (kW)*	6.5 kW
Heat output (kW)*	4.6 kW



Odense

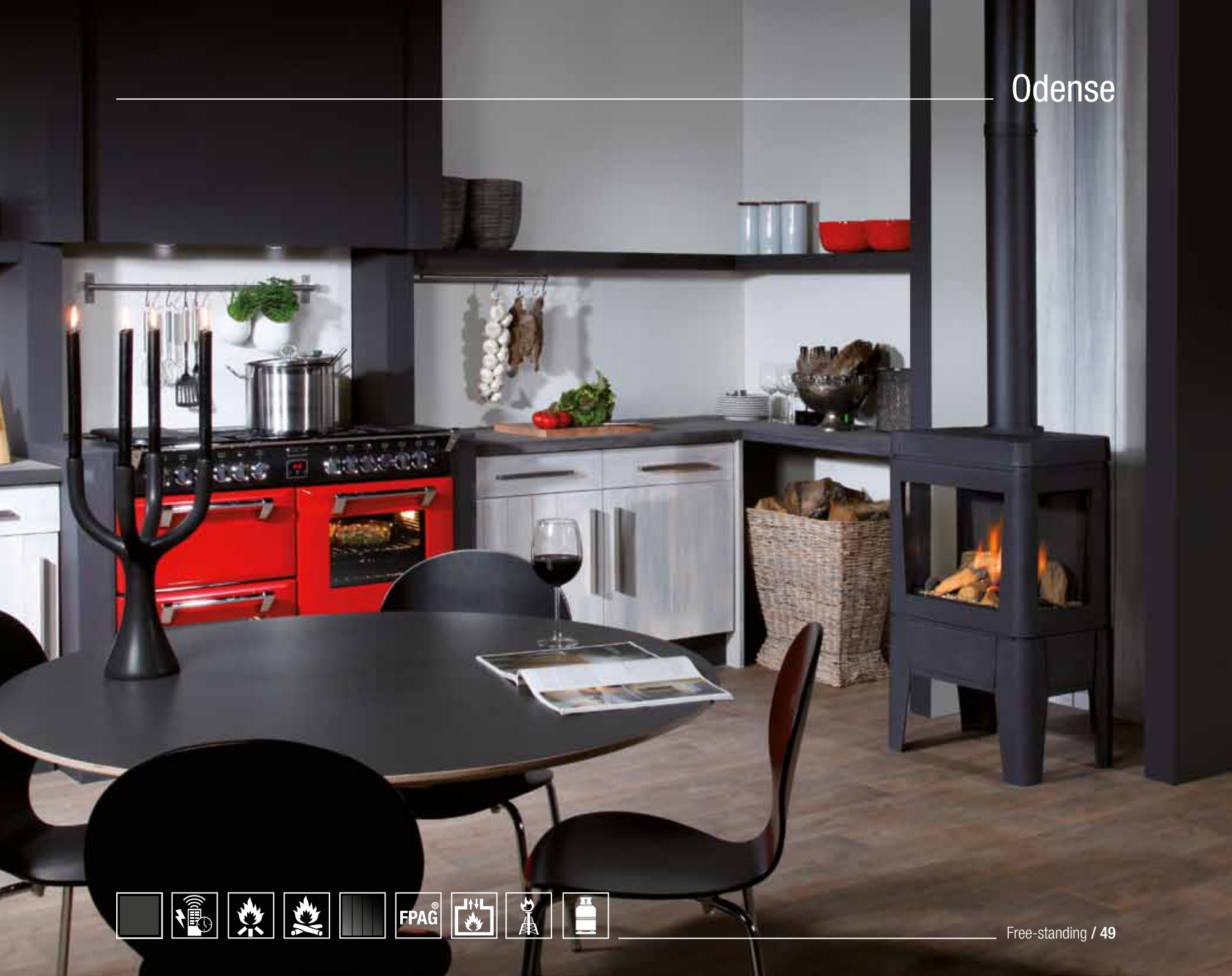

Free-standing / 49

- Ⓝ Moderne vrijstaande 3-zijdige hanghaard in zwart gietijzer.
- Ⓔ Free-standing 3-sided hanging gas fire in black cast iron.
- Ⓓ Freistehender 3-seitig verglaster Wandkamin in schwarzem Gusseisen.
- Ⓕ Foyer à trois faces en fonte noire.

# Skive



	Skive
Input (kW)*	6.5 kW
Heat output (kW)*	4.6 kW

Skive



Free-standing / 51

- Ⓝ Vrijstaande haard met optioneel een bekleding van speksteen.
- ⓔ Free-standing gas stove with hot plate of soapstone is optional.
- ⓓ Freistehender Kaminofen, ist auch mit Specksteinverkleidung erhältlich.
- ⓔ Foyer isolé avec habillage de pierre ollaire en option.

# Vaska



	Vaska
Input (kW)*	6.9 kW
Heat output (kW)*	4.8 kW

Vaska

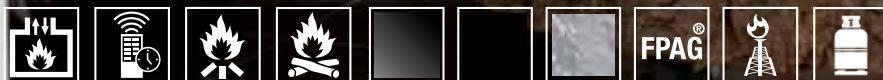

Free-standing / 53

# Outdoor

---



- Ⓝ Een tuin is tegenwoordig geen decor meer, maar bedoeld om in te leven en te genieten. Een comfortabel zitgedeelte mag hierin niet ontbreken. De buitentrend is van een eettafel met stoelen verschoven naar een loungeset met haard. Maar nog belangrijker dan meubels is warmte. Juist dat bepaalt op een terras het gevoel van comfort. De Faber buitenhaarden op gas voegen met de 'instant' sfeer direct dat extra toe.
- Ⓔ Nowadays a garden is no longer only decorative, but it is intended to be used as living space. A comfortable seating area is a must. The outside trend has moved from a simple garden table and garden chairs to a lounge set with an open fire. But even more important than furniture is heat. That is the one thing that determines the comfort level on a patio. Faber's outside gas fires immediately add that extra atmospheric element.
- Ⓓ Ein Garten ist heutzutage kein Dekor mehr, sondern zum Leben und Genießen da. Eine komfortable Sitzgruppe darf dabei nicht fehlen. Der Gartentrend geht von einem Esstisch mit Stühlen hin zu einem Loungeset mit Kamin. Aber noch wichtiger als Möbel ist Wärme. Eben das bestimmt auf einer Terrasse das Gefühl der Behaglichkeit. Die Faber Außenkamine auf Gas tragen mit der 'Instant-Stimmung' direkt dazu bei.
- Ⓕ Un jardin est aujourd'hui plus qu'un décor, mais plus pour y vivre et se détendre. Un coin confortable n'y peut pas manquer. La tendance extérieur s'est altéré d'un coin repas vers un loungeset avec foyer. Plus important que l'aménagement est la chaleur, ce qui détermine la sensation de confort. Les foyers d'extérieurs à gaz offrent l'ambiance demandée.

- Ⓝ Het is ook mogelijk om de Faber buitenhaarden op een gewone gasleiding aan te sluiten met een zogenaamd gasstopcontact.
- Ⓔ It is also possible to connect the outside fires to the gas mains by means of a so-called gas socket.
- Ⓓ Es ist auch möglich, die Faber-Außenkamine mit einer sogenannten Gassteckdose an eine normale Gasleitung anzuschließen.
- Ⓕ Il est également possible de raccorder le foyer d'extérieur Faber sur un tuyau de gaz direct, avec la prise de gaz.





 **faber**

- Ⓝ Strak vormgegeven verrijdbare stalen buitenhaard op gas. Stalen asbak is optioneel. TheBUZZ wordt geleverd met een luxe beschermhoes.
- Ⓔ Starkly designed steel mobile outdoor gas fire which runs on gas. Ashtray is optional. TheBUZZ comes with a protective cover.
- Ⓓ Gradliniger fahrbarer Stahl-Außenkamin mit Gasbetrieb. Aschenbecher optional. TheBUZZ wird mit luxuriöser Schutzhülle geliefert.
- Ⓕ Foyer d'extérieur mobile en acier qui fonctionne à gaz. Cendrier design en option. TheBUZZ est livré avec housse de protection luxueuse.

- Ⓝ TheBUZZ is ook verkrijgbaar in Corten staal. Dit staal is een metaallegering, bestaande uit ijzer waaraan koper, fosfor, silicium, nikkel en chroom zijn toegevoegd. De bruine roestkleur is het meest typische uiterlijke kenmerk.
- Ⓔ TheBUZZ is also available in Corten steel. This steel is a metal alloy consisting of iron to which copper, phosphorus, Silicon, nickel and chromium are added. The brown rust color is the most typical feature.
- Ⓓ Der Buzz ist auch in COR-TEN Stahl Ausführung lieferbar. Die Legierung besteht unter anderem aus Kupfer, Phosphor, Silizium, Nickel und Chrom. Die rostfarbene Patina ist das typische Merkmal dieses besonderen Materials.
- Ⓕ The Buzz est également disponible en acier Corten. Cet acier est un alliage, composé de fer auquel est ajouté le cuivre, phosphore, silicium, nickel et chrome. La brun rougeâtre étant son aspect caractéristique.



## theBUZZ

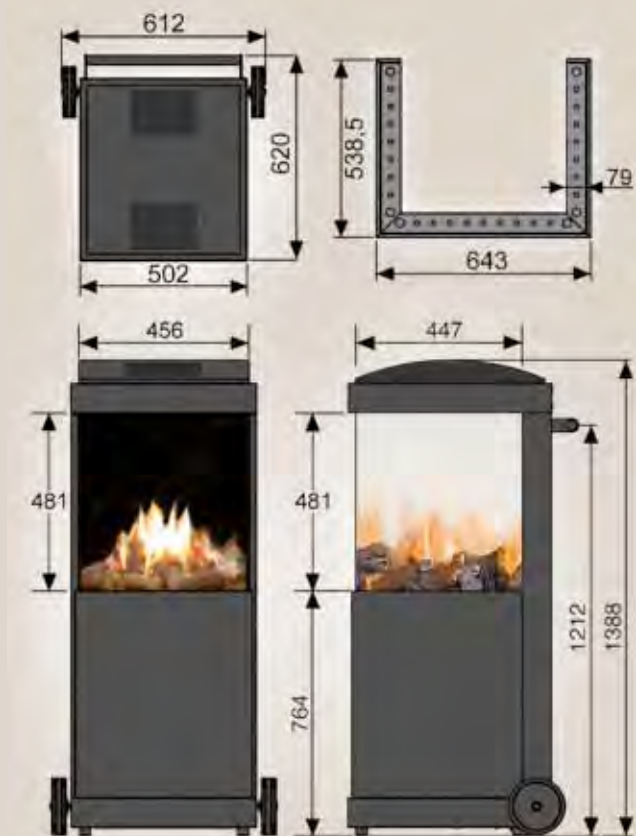

Input (kW)*	9.3 kW
Consumption	0.7 kg/h
Ash-tray	Optional
Gas socket	Optional
Burner	Log-Burner



Designed by *Neos Travels*



- Ⓝ Moderne frameless buitenhaard op gas. Zowel vrijstaand als ingebouwd te gebruiken. En ook als enkelzijdige of doorkijkhaard plaatsbaar.
- ⓔ Modern frameless outdoor gas fire. Can be used freestanding or built-in, single-sided or as a see-through fire.
- ⓓ Moderner rahmenloser Gas-Aussenkamin. Als freistehender, sowie als Einbaukamin und auch einseitig oder als Tunnelmodell zu platzieren.
- ⓕ Foyer d'extérieur moderne à gaz. Utilisable indépendant ainsi qu'encastré, et à installer en tant que foyer simple, que foyer transparent.

## theMOOD

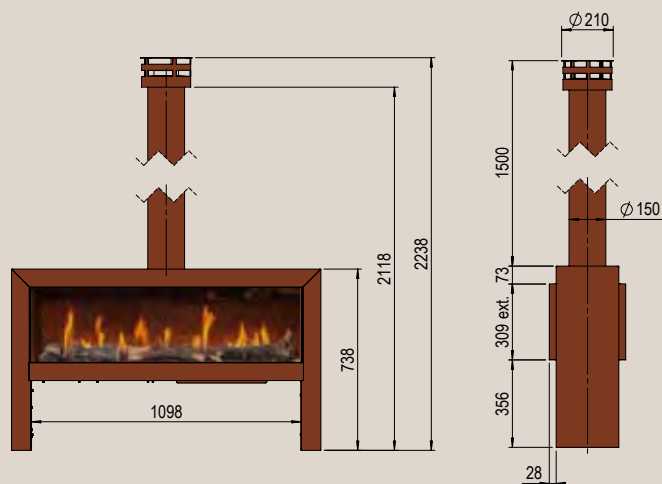
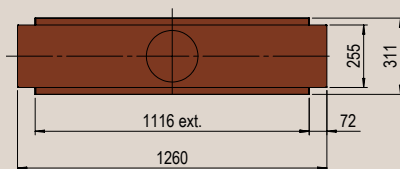

Input (kW)*	12.4 kW
Consumption	0.9 kg/h
Gas socket	Optional
Burner	Tube-Burner
Extension pipe, 1 mtr	Optional
Flue pipe incl. terminal	Optional

theMOOD



- Ⓝ Fraai vormgegeven ronde verrijdbare buitenhaard op gas met standaard asbak. TheTUBE wordt geleverd met een luxe beschermhoes.
- ⓔ Modern designed round mobile outdoor gas fire on gas with an ashtray. TheTUBE comes with a protective cover.
- ⓓ Wunderschön gestalteter runder, fahrbarer Gas-Aussenkamin mit serienmäßigem Aschenbecher. TheTUBE wird mit luxuriöser Schutzhülle geliefert.
- ⓕ Splendide foyer d'extérieur amovible aux formes rondes. Cet appareil fonctionne à gaz et est équipé d'un cendrier design. TheTUBE est livré avec housse de protection luxueuse.

## theTUBE



Input (kW)*	6.5 kW
Consumption	0.5 kg/h
Ash-tray	Included
Gas socket	Optional
Burner	Tube-Burner

theTUBE



Designed by *Neus Jacobs*





**NL Wist u dat ook al onze haarden verkrijgbaar zijn in SketchUp?**

SketchUp is een 3D teken- en ontwerpprogramma dat zowel door professionals als door consumenten gebruikt kan worden.

Hoe werkt het?

U kunt de basisversie van Sketchup gratis downloaden en aansluitend uw project openen. Om u van dienst te zijn, heeft Faber haar gehele assortiment sfeerhaarden in SketchUp beschikbaar gemaakt (zoekcode faber haarden). Via SketchUp warehouse zijn alle Faber haarden te vinden welke u in uw eigen ontwerp kunt importeren. U kunt nu moeiteloos een Faber haard in uw woonkamer, slaapkamer of elk ander vertrek tekenen. Hiermee kunt u dus thuis eenvoudig uw eigen 3D ontwerp maken! Uw Faber dealer, te vinden op [www.faber.nl](http://www.faber.nl), helpt u vervolgens graag met de realisatie van uw eigen ontwerp.

**E Did you already know that our fires are available in SketchUp?**

SketchUp is 3D drawing and design software that can be used by both professionals and laymen.

How does it work?

You can download the free basic version of SketchUp and then open your project. In order to be of service to you, Faber has made her entire range of fires available in SketchUp (search code faber haarden). You can find all Faber fires in the SketchUp Warehouse and import them into your own design. Now you can effortlessly draw a Faber fire in your living room, bedroom or any other room. So you can simply make your own 3D design at home! Your local Faber dealer, to be found on [www.faberfires.com](http://www.faberfires.com), will then be happy to help you with the realisation of your design.



**D Wussten Sie, dass alle unsere Kamine auch in SketchUp erhältlich sind?**

SketchUp ist ein 3D-Zeichen- und Entwurfsprogramm, das sowohl von Profis als auch von Verbrauchern verwendet werden kann.

Wie funktioniert das Ganze?

Sie können die Basisversion von Sketchup kostenlos herunterladen und anschließend Ihr Projekt öffnen. Um Ihnen behilflich zu sein, hat Faber sein gesamtes Sortiment an Gaskaminen in SketchUp zur Verfügung gestellt (Suchcode faber haarden). Über SketchUp Warehouse sind alle Faber-Kamine zu finden, die Sie in Ihren eigenen Entwurf importieren können. Sie können jetzt mühelos einen Faber-Kamin in Ihr Wohnzimmer, Schlafzimmer oder jeden weiteren Raum einzeichnen. Damit können Sie also zu Hause einfach Ihren eigenen 3D-Entwurf erstellen! Ihr Faber-Händler, der unter [www.faber-kamine.de](http://www.faber-kamine.de) zu finden ist, ist Ihnen daraufhin gerne bei der Realisierung Ihres eigenen Entwurfs behilflich.

**F Saviez-vous que tous nos foyers sont disponibles en SketchUp?**

SketchUp est un logiciel pour dessiner et créer en 3D qui peut être utilisé par des professionnels ainsi que des consommateurs.

Comment ça fonctionne?

Vous pouvez télécharger la version SketchUp de base gratuite et ensuite ouvrir votre projet. Pour vous servir, Faber a mis toute sa gamme de foyers à votre disponibilité dans SketchUp (clé de recherche: faber haarden). Au Warehouse SketchUp vous trouverez tous les foyers Faber, que vous pouvez intégrer dans votre projet. Vous pouvez maintenant dessiner un foyer Faber dans votre séjour, chambre à coucher ou toute autre pièce. Avec cet outil vous pouvez donc facilement créer votre plan en trois dimensions! Votre revendeur Faber, à retrouver au [www.faber.be](http://www.faber.be) vous aidera ensuite avec la réalisation de votre dessin.



# Technical Icons

Voor meer inspiratie bent u tijdens kantoor uren  
van harte welkom in onze showroom in Heerenveen!



Gesloten verbranding  
Balanced flue  
Geschlossenes Verbrennungssystem  
Combustion fermé



Open verbranding  
Conventional flue  
Offenes Verbrennungssystem  
Combustion ouvert



Inbouw  
Built-in  
Einbau  
À Encastrer



Afstandsbediening  
Remote control  
Fernbedienung  
Télécommande



Afstandsbediening de luxe (GV60 met TT en aut. ontsteking)  
Remote control de luxe (GV60 with TT and ignition)  
Fernbedienung de luxe (GV60 mit TT und elektronischer Zündung)  
Télécomm. de luxe (GV60, therm.progr. et allumage autom.)



SIT



Afstandsbediening ITC App  
Remote control ITC App  
Fernbedienung ITC App  
Télécommande ITC App



Log Burner®



Flat Burner®



Emberbed Burner®



Step Burner®



Aardgas  
Natural gas  
Erdgas  
Gaz



Propan  
Propane gas  
Propan  
Propane



FPAG® Future  
Proof All Gasses



ITC-App



Achterwand staal vlak  
Flat steel interior  
Rückwand Stahl  
Plaque de fond acier



Achterwand staal lamel  
Ribbed steel interior  
Rückwand Lamellen Stahl  
Plaque de fond en lamelles en acier



Achterwand zwart spiegelglas  
Black mirror glass interior  
Rückwand schwarzes Spiegelglas  
Plaque de fond en miroir noir



Gebogen achterwand staal  
Curved steel rear wall  
Gebogene Rückwand Stahl  
Plaque de fond courbé en acier



Houtstammen  
Logs  
Holzscheite  
Jeu de bois



Grijze splitsteen  
Grey stone chippings  
Matt graue Keramiksplitter  
Eclats de granit



Carrara kiezel  
Carrara pebbles  
Carrara Kiesel  
Galets de Carrare

## SCHOUW | SURROUND | FASSADE | MANTEAU | ARTIFICIAL MARBLE



Gepolijst  
Polished  
Poliert  
Poli



Gezoet  
Sweetened  
Geschliffen  
Rvabotée



Steenmotief  
Brick line  
Steinmotiv  
Impression pierre



Steenmotief Nostalgic  
Brick line Nostalgic  
Steinmotiv Nostalgic  
Impression pierre Nostalgique



Steenmotief Nostalgic + haardplaat  
Brick line Nostalgic with motif  
Steinmotiv Nostalgic mit Gussplatte  
Impression pierre Nostalgique avec plaque de cheminée



Wirдум  
670



Wirдум  
670



RVS  
Stainless steel  
Edelstahl  
Acier inox



Zwart  
Black  
Schwarz  
Noir



Zwart / Antraciet  
Black / Anthracite  
Schwarz / Anthrazit  
Noir / Anthracite



Corten staal  
Corten steel  
Stahl Rosteffekt  
Acier Corten



Gietijzer  
Cast iron  
Gusseisen  
Fonte



Speksteen  
Soapstone  
Speckstein  
Pierre oilaire

- Ⓜ De Maattekeningen / technische gegevens / kleuren zijn geen uitgangspunt voor het treffen van installatievoorbereidingen. Modelwijzigingen voorbehouden. Niet ieder model is automatisch beschikbaar in ieder land.
- ⓔ The scale drawings / technical data / colours referred to are subject to change. Not every model is automatically available in each country.
- Ⓛ Für die angegebenen Maße / Daten / Farben wird keine Gewähr übernommen. Technische Änderungen vorbehalten. Nicht alle Modelle sind automatisch für jedes Land verfügbar.
- ⓕ Les croquis avec dimensions / données technique / coloris ne constituent pas la base sur laquelle prendre les mesures préparatoires en vue de l'installation. Chaque modèle n'est pas automatiquement disponible dans chaque pays.

Glen Dimplex Benelux BV  
Saturnus 8  
NL-8448 CC Heerenveen  
PO Box 219  
NL-8440 AE Heerenveen  
t +31 (0)513 656 500  
f +31 (0)513 656 501  
e [info@faber.nl](mailto:info@faber.nl)  
i [www.faber.nl](http://www.faber.nl)

Glen Dimplex Benelux BV  
Vestiging België/Adresse Belgique  
Burgemeester Maenhoutstraat 64  
B-9820 Merelbeke  
t +32 (0)9 210 02 10/210 02 11  
f +32 (0)9 210 02 12  
e [info@faber.be](mailto:info@faber.be)  
i [www.faber.be](http://www.faber.be)

Faber Deutschland  
Vertriebsbüro Project1711 GmbH & Co. KG  
Im Gewerbegebiet 12  
D-48612 Horstmar  
t +49 (0)2558 9973880  
f +49 (0)2558 9973881  
e [info@faber-kamine.de](mailto:info@faber-kamine.de)  
i [www.faber-kamine.de](http://www.faber-kamine.de)

Nederland, Heerenveen:  
Showroom open: maandag - vrijdag 9.00 -17.00 uur. Afspraak op aanvraag.  
Raadpleeg onze website voor de speciale zaterdag openingen.

België / Belgique, Merelbeke:  
Showroom open: maandag - vrijdag 8.30 -12.00 uur, 13.00 - 17.00 uur.  
La salle d'exposition est ouverte: lundi - vendredi 8.30 -12.00 h, 13.00 -17.00 h.

REVENDEUR AGRÉÉ

## Faber Special Gas

2015-2016

Austria  
Linhart GesmbH  
+43 (0)316471543-0  
[www.faber-kamine.at](http://www.faber-kamine.at)

France  
Best Fires  
[www.best-fires.fr](http://www.best-fires.fr)

Iceland  
Parki Interiors  
+354 5950575  
[www.parki.is](http://www.parki.is)

Italy  
Furlanis Ricostruzione s.r.l.  
+39 0421394343  
[www.dim-ora.it](http://www.dim-ora.it)

Norway  
Tolcon AS  
+47 22666670  
[www.tolcon.no](http://www.tolcon.no)

Russia  
Nortech Ltd.  
+78123275019  
[www.faber-kamin.ru](http://www.faber-kamin.ru)  
[www.nortech.ru](http://www.nortech.ru)

Turkey  
Arkiline  
+90 2163451500  
[www.arkifire.com](http://www.arkifire.com)

Czech Republic  
Gazcom s.r.o  
+42 0776823270  
[www.gazcom.cz](http://www.gazcom.cz)

Greece  
C. Gregoriou  
+30 2108616850  
[www.grigoriou.com.gr](http://www.grigoriou.com.gr)

Ireland  
Dimpcó  
+353 (0)1 8424833  
[www.dimpco.ie](http://www.dimpco.ie)

Latvia  
Acorem  
+371 67327638  
[www.acorem.lv](http://www.acorem.lv)

Portugal  
Chamilar  
+351 232952252  
[www.chamilar.pt](http://www.chamilar.pt)

Spain  
Bosch Marín, s.l.  
+34 938970888  
[www.boschmarin.com](http://www.boschmarin.com)

United Kingdom  
GDC Group LTD  
+44 (0)8456005111  
[www.gdcgroup.co.uk](http://www.gdcgroup.co.uk)

Denmark  
Living Flames  
+45 7020 5130  
[www.livingflames.dk](http://www.livingflames.dk)

Hungary  
Faber Holland Magyar Kft.  
+361 4369220  
[www.faberhungary.hu](http://www.faberhungary.hu)

Israel  
Carmel Heating Faber  
+972 (0)36199877  
[www.carmel-heating.co.il](http://www.carmel-heating.co.il)

Luxemburg  
Plaisir du Feu  
+35 2314891  
[www.plaisirdufeu.lu](http://www.plaisirdufeu.lu)

Romania  
E.G.S. Building Construct  
+40 0744758358  
[www.semineeromania.ro](http://www.semineeromania.ro)

Switzerland  
Attika Feuer AG  
+41 417848080  
[www.attika.ch](http://www.attika.ch)